

1695

CHF 720

N - GA

Portabiti
Coat stand
Portemanteau
Perchero
Garderobenständer

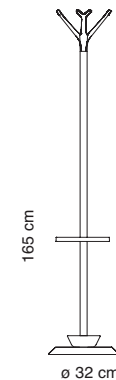

1696

CHF 770

N - GA

Portabiti con portaombrelli
Coat stand with umbrella ring
Portemanteau avec anneau porte-parapluies
Perchero con aro paragüero
Garderobenständer mit Schirmring

Anche per uso esterno
Also for outdoor use
Utilisable aussi à l'extérieur
Tambien para exterior
Auch für Aussenanwendung

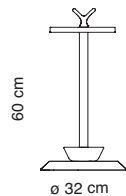

1692

CHF 445

N - GA

Portaombrelli
Umbrella stand
Porte-parapluies
Paragüeros
Schirmständer

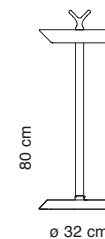

1693-NM

CHF 376

NM

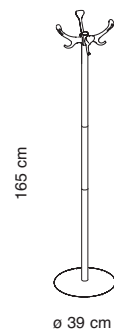

Posacenere / portaoggetti
Ashtray / Objects holder
Cendrier / Porte-objets
Cenicero / Portaobjetos
Aschenbecher / Behälter



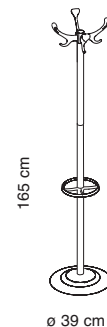

CD.	1475	1475-TGA	1475-TBGA	1475-GGA
PR.	CHF 300	CHF 329	CHF 329	CHF 339
CL.	N	GA	GA	GA
DS.	Verniciato - Testa nera Powder-coated - Black top Epoxy - Tête noire Pintado - Cabeza negra Beschichtet - Kopf schwarz	Verniciato - Testa trasparente Powder-coated - Transparent top Epoxy - Tête transparente Pintado - Cabeza transparente Beschichtet - Kopf transparent	Verniciato - Testa blu trasparente Powder-coated - Blue transparent top Epoxy - Tête bleu transparente Pintado - Cabeza azul transparente. Beschichtet - Kopf blau transparent	Verniciato - Testa grigio argento Powder-coated - Silver grey top Epoxy - Tête gris argenté Pintado - Cabeza gris plata Beschichtet - Silbergrau Kopf

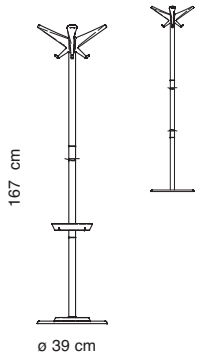
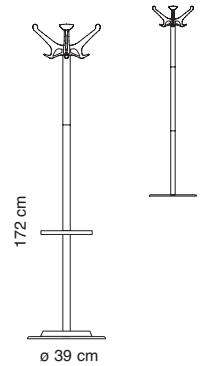

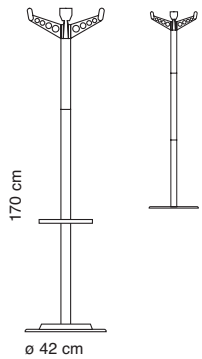
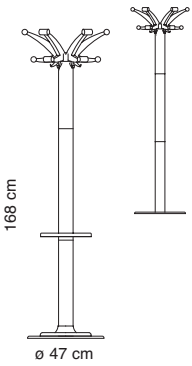

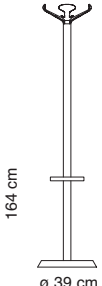
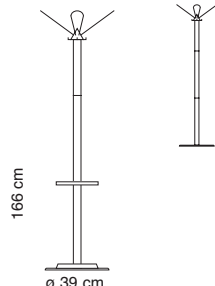
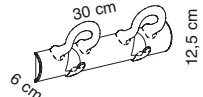

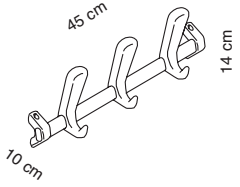
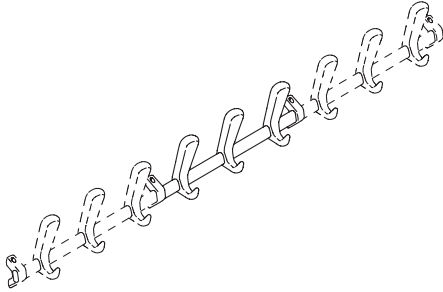
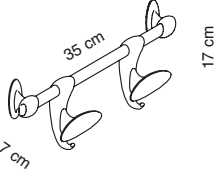
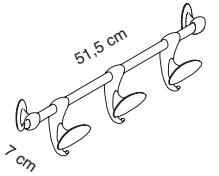
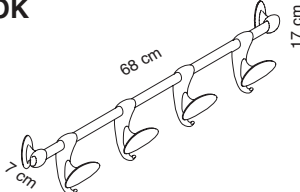
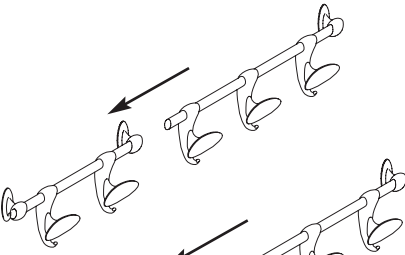
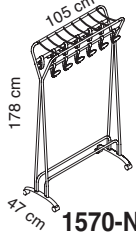
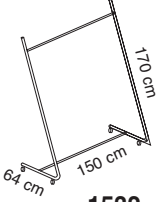
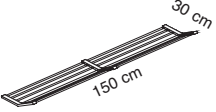

CD.	1476	1476-TGA	1476-TBO	1476-TBGA	1476-GGA
PR.	CHF 316	CHF 345	CHF 345	CHF 345	CHF 356
CL.	N	GA	BO	GA	GA
DS.	Verniciato - Testa nera Powder-coated - Black top Epoxy - Tête noire Pintado - Cabeza negra Beschichtet - Kopf schwarz	Verniciato - Testa trasparente Powder-coated - Transparent top Epoxy - Tête transparente Pintado - Cabeza transparente Beschichtet - Kopf transparent	Verniciato - Testa trasparente Powder-coated - Transparent top Epoxy - Tête transparente Pintado - Cabeza transparente Beschichtet - Kopf transparent	Verniciato - Testa blu trasparente Powder-coated - Blue transparent top Epoxy - Tête bleu transparente Pintado - Cabeza azul transparente. Beschichtet - Kopf blau transparent	Verniciato - Testa grigio argento Powder-coated - Silver grey top Epoxy - Tête gris argenté Pintado - Cabeza gris plata Beschichtet - Silbergrau Kopf

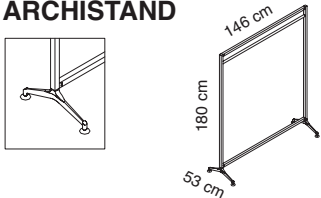
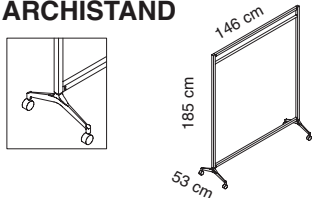
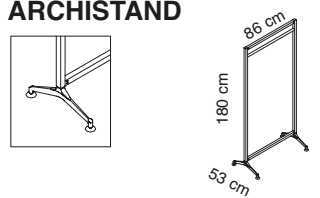
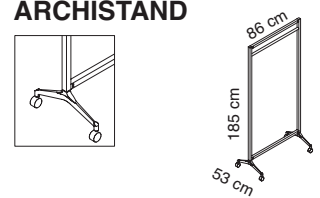
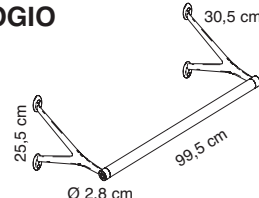
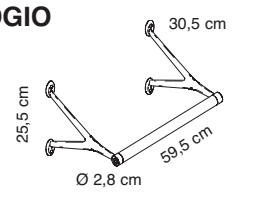
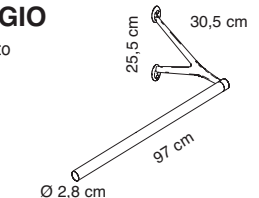
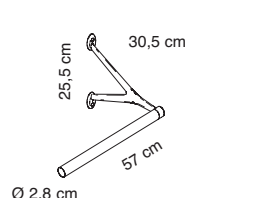
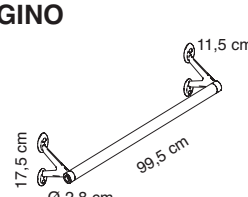
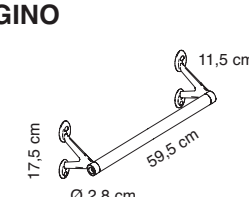
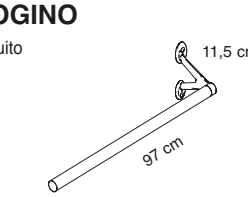
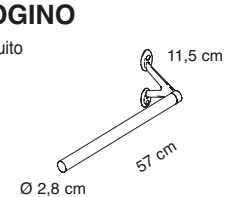
	<p>SWING</p> <p>Portaombrelli asportabile Removable umbrella-holder Porte-parapluies emportable Paragüero exportable Demontierbarer Schirmhalter</p> 			<p>KING</p> <p>Portaombrelli asportabile Removable umbrella-holder Porte-parapluies emportable Paragüero exportable Demontierbarer Schirmhalter</p> 			<p>QUADRANGOLO</p> 	
CD.	1486-N	1486-B	1486-BT	1485-N	1485-GA	1485-TGA	1488-BO	
PR.	CHF 339	CHF 339	CHF 369	CHF 314	CHF 314	CHF 330	CHF 278	
CL.	N	B	B	N	GA	GA	BO	
DS.	Verniciato - Testa nera Powder-coated - Black top Epoxy - Tête noire Pintado - Cabeza negra Beschichtet - Kopf schwarz	Verniciato - Testa bianca Powder-coated - White top Epoxy - Tête blanche Pintado - Cabeza blanca Beschichtet - Kopf weiss	Verniciato - Testa trasparente Powder-coated - Transparent top Epoxy - Tête transparente Pintado - Cabeza transparente Beschichtet - Kopf transparent	Verniciato - Testa nera Powder-coated - Black top Epoxy - Tête noire Pintado - Cabeza negra Beschichtet - Kopf schwarz	Verniciato - Testa grigia Powder-coated - Grey top Epoxy - Tête gris Pintado - Cabeza gris Beschichtet - Kopf grau	Verniciato - Testa trasparente Powder-coated/Transparent top Epoxy - Tête transparente Pintado - Cabeza transparente Beschichtet - Kopf transparent	Verniciato - Testa bianca Powder-coated - White top Epoxy - Tête blanche Pintado - Cabeza blanca Beschichtet - Kopf weiss	
	<p>TRALICCIO</p> <p>Portaombrelli asportabile Removable umbrella-holder Porte-parapluies emportable Paragüero exportable Demontierbarer Schirmhalter</p> 			<p>JOKER</p> <p>Portaombrelli asportabile Removable umbrella-holder Porte-parapluies emportable Paragüero exportable Demontierbarer Schirmhalter</p> 				
CD.	1505		1505-GA		1480		1480-C	
PR.	CHF 302		CHF 302		CHF 365		CHF 439	
CL.	N		GA		N		C	
DS.	Verniciato - Testa nera Powder-coated - Black top Epoxy - Tête noire Pintado - Cabeza negra Beschichtet - Kopf schwarz		Verniciato - Testa nera Powder-coated - Black top Epoxy - Tête noire Pintado - Cabeza negra Beschichtet - Kopf schwarz		Verniciato - Testa nera Powder-coated - Black top Epoxy - Tête noire Pintado - Cabeza negra Beschichtet - Schwarzer Kopf		Cromato - Testa nera Chrome-plated - Black top Chromé - Tête noire Cromado - Cabeza negra Verchromt - Schwarzer Kopf	

	EVA Portaombrelli asportabile Removable umbrella-holder Porte-parapluies emportable Paragüero exportable Demontierbarer Schirmhalter	 <p>164 cm ø 39 cm</p>	PETALO Portaombrelli asportabile Removable umbrella-holder Porte-parapluies emportable Paragüero exportable Demontierbarer Schirmhalter	 <p>166 cm ø 39 cm</p>
CD.	1483-N	1483-GA	1515	1515-GA
PR.	CHF 136 / Stück	CHF 136 / Stück	CHF 206 / Stück	CHF 206 / Stück
CD.	1483M-N	1483M-GA	1515M	1515M-GA
PR.	CHF 114 / Stück. Prezzo per ordini superiori a 6 pz. Price for orders over 6 pcs. Prix pour c.des supérieures à 6 pcs. Precio para mas de 6 pzs Preis für Aufträge von über 6 Stück	CHF 114 / Stück Prezzo per ordini superiori a 6 pz. Price for orders over 6 pcs. Prix pour c.des supérieures à 6 pcs. Precio para mas de 6 pzs Preis für Aufträge von über 6 Stück	CHF 159 / Stück Prezzo per ordini superiori a 6 pz. Price for orders over 6 pcs. Prix pour c.des supérieures à 6 pcs. Precio para mas de 6 pzs Preis für Aufträge von über 6 Stück	CHF 159 / Stück Prezzo per ordini superiori a 6 pz. Price for orders over 6 pcs. Prix pour c.des supérieures à 6 pcs. Precio para mas de 6 pzs Preis für Aufträge von über 6 Stück
CL.	N	GA	N	GA
DS.	Verniciato - Testa nera Powder-coated - Black top Epoxy - Tête noire Pintado - Cabeza negra Beschichtet - Kopf schwarz	Verniciato - Testa grigia Powder-coated - Grey top Epoxy - Tête gris Pintado - Cabeza gris Beschichtet - grau Kopf	Verniciato - Testa nera Powder-coated - Black top Epoxy - Tête noire Pintado - Cabeza negra Beschichtet - Kopf schwarz	
	DUO  <p>30 cm 12.5 cm 6 cm</p>			
CD.	1519-N	1519-BO		
PR.	CHF 69 / Stück	CHF 79 / Stück		
CD.	1519M-N	1519M-BO		
PR.	CHF 55 / Stück Prezzo per ordini superiori a 6 pz. Price for orders over 6 pcs. Prix pour c.des supérieures à 6 pcs. Precio para mas de 6 pzs Preis für Aufträge von über 6 Stück	CHF 60 / Stück Prezzo per ordini superiori a 6 pz. Price for orders over 6 pcs. Prix pour c.des supérieures à 6 pcs. Precio para mas de 6 pzs Preis für Aufträge von über 6 Stück		
CL.	N	BO		
DS.	Portabiti da parete in tecnopolimero Wall-mounted coat-hooks in high-tech polymer Portemanteau mural en techno-polymère Perchero da pared realizado en tecnopolimero Wandgarderobe aus Polymer			

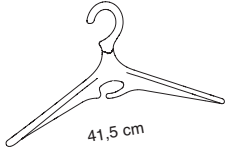
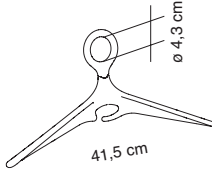
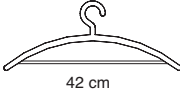
	<p>SWING</p> 																	
CD.	1523-N			1523-B			1523-T											
PR.	CHF 197			CHF 197			CHF 201											
CL.	N			B			T											
DS.	<p>Portabiti da parete cromato con ganci in tecnopolimero nero, bianco e trasparente Wall-mounted chrome-plated coat rail, hooks in black, white or transparent high.tech polymer Portemanteau mural chromé avec crochets en techno-polymère blanc, noir ou transparent Perchero de pared cromado con ganchos de tecnopolimero negro, blanco o transparente Verchromte Wandgarderobe mit Haken aus Polymer schwarz, weiss oder transparent</p>																	
	<p>HOOK</p> 			<p>HOOK</p> 			<p>HOOK</p> 											
CD.	1562	1562-TT	1562-T	1563	1563-TT	1563-T	1564	1564-TT	1564-T									
PR.	CHF 80	CHF 106	CHF 106	CHF 99	CHF 136	CHF 136	CHF 117	CHF 163	CHF 163									
CL.	N	T	TB	N	T	TB	N	T	TB									
DS.	<p>Portabiti da parete cromato con gancio in policarbonato nero, trasparente o blu trasparente Chrome-plated wall-mounted coat rail with black, transparent or blue transparent polycarbonate hook Portemanteaux mural chromé avec crochet en polycarbonate noir, transparent ou bleu transparent Perchero de pared cromado con gancho en policarbonato negro, transparente o azul transparente Verchromte Wandgarderobe mit Haken aus Polikarbonat schwarz, transparent oder blau transparent</p>																	
	<p>HOOK STANDER</p>  <p>1570-NN</p>						<p>STANDER</p>  <p>1532</p>						<p>STANDER</p>  <p>1533</p>					
PR.	CHF 655						CHF 458						CHF 196					
CL.	N						N						N					
DS.	<p>Struttura nera, ganci neri Black frame, black hooks Structure noire, crochets noirs Estructura negra, ganchos negros Gestell und Haken schwarz</p>																	

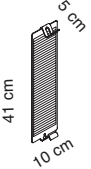
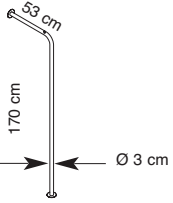
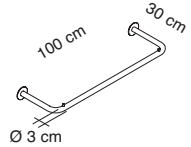
	<p>ARCHISTAND</p>  <p>5211-P</p>	<p>ARCHISTAND</p>  <p>5211-R</p>	<p>ARCHISTAND</p>  <p>5210-P</p>	<p>ARCHISTAND</p>  <p>5210-R</p>
CD.				
PR.	CHF 613	CHF 638	CHF 558	CHF 583
CL.	GA	GA	GA	GA
DS.	<p>Stander portabiti in acciaio cromato e verniciato con polveri epossidiche. Base in alluminio Free standing powder-coated and chrome-plated steel coat rail. Aluminium base Portemanteaux en acier peint et chromé en époxy. Base en aluminium Barra perchero en acero pintado y cromado con polvo epoxi. Base en aluminio Kleiderständer aus mit Epoxypulver beschichtetem und verchromtem Stahl. Füsse aus Aluminium</p>			
	<p>AMBROGIO</p>  <p>1546</p>	<p>AMBROGIO</p>  <p>1547</p>	<p>AMBROGIO Modulo seguito Add-on unit</p>  <p>1548</p>	<p>AMBROGIO Modulo seguito Add-on unit</p>  <p>1549</p>
CD.				
PR.	CHF 307	CHF 302	CHF 202	CHF 197
CL.	C	C	C	C
DS.	<p>Barra porta grucce Wall-fixed coat rail Barre porte-cintres Colgador a pared para perchas Wandgarderobe</p>		<p>Barra porta grucce - modulo seguito Wall-fixed coat rail - add-on unit Barre porte-cintres - module suivant Colgador a pared para perchas - continuacion Wandgarderobe - Verlängerungsstück</p>	
	<p>AMBROGINO</p>  <p>1551</p>	<p>AMBROGINO</p>  <p>1552</p>	<p>AMBROGINO Modulo seguito Add-on unit</p>  <p>1553</p>	<p>AMBROGINO Modulo seguito Add-on unit</p>  <p>1554</p>
CD.				
PR.	CHF 283	CHF 278	CHF 192	CHF 187
CL.	C	C	C	C
DS.	<p>Barra porta grucce Wall-fixed coat rail Barre porte-cintres Colgador a pared para perchas Wandgarderobe</p>		<p>Barra porta grucce - modulo seguito Wall-fixed coat rail - add-on unit Barre porte-cintres - module suivant Colgador a pared para perchas - continuacion Wandgarderobe - Verlängerungsstück</p>	

	HANGER 			OMETTO 		OMETTO 		SOSIA 	
CD.	1527/4-N 1527/4-B 1527/4-R			1537/4		1538/4		1530/4	
PR.	CHF 57 (4 pcs) CHF 57 (4 pcs) CHF 57 (4 pcs)			CHF 48 (4 pcs)		CHF 52 (4 pcs)		CHF 43 (4 pcs)	
CL.	N B R			N - GR		N		N	
DS.	Gruccia portabiti in ABS ABS hanger Cintre en ABS Perchas ometto en ABS Kleiderbügel aus ABS			Gruccia portabiti in polipropilene Polypropylene hanger Cintre en polypropylène Perchas ometto en polipropileno Kleiderbügel aus Polypropilen					
			per cod.: 1537/4 for ref.: 1530/4			MOTO			
CD.	1529/8		1539			1556-GA			
PR.	CHF 62 (8 pcs)		CHF 774 (100 pcs)			CHF 100			
CL.	N		N - R - BL - VE - GL			GA			
DS.	Gruccia portabiti in polipropilene Polypropylene hanger Cintre en polypropylène Perchas ometto en polipropileno Kleiderbügel aus Polypropilen		Marca + contromarca (100 pcs) Token (100 pcs) Contromarque (100 pcs) Señales para perchas (100 pcs) Beschriftungsschilder (100 pcs) (numeri colorati/coloured numbers/chiffres colorés/números colorados/farbige Nummern)			Portacasco con gancio portabiti Helmet and clothes hanger Porte-casque et portemanteau Portacasco y perchero Helm- und Kleiderständer			
	WAVE 		WAVE 			WAVE 		WAVE 	
CD.	1576 *		1572 *			1578/4 *		1579/2 *	
PR.	CHF 477		CHF 399			CHF 29 (4 pcs)		CHF 19 (2 pcs)	
CL.									
DS.	Barra porta grucce Coat hanger rail Barre porte-cintres Barra porta perchas Kleiderbügelstange					Gancio portabiti in acciaio Steel clothes hook Crochet en acier Gancho perchero de acero Kleiderhaken aus Stahl		Gruccia in acciaio Steel coat hanger Cintre en acier Percha de acero Kleiderbügel aus Stahl	
(*) Disponibile fino ad esaurimento scorte - (*) Available until selling out - (*) Disponible jusqu'à l'épuisement du stock - (*) Disponible hasta agotamiento de las reservas - (*) Solange der Vorrat reicht									

				Per art. For code: 1000-GA 1000-B			Per art. For code: 1000-GA 1000-B
CD.	1000-GA	1000-B	1020-B		1022-S		
PR.	CHF 276	CHF 276	CHF 132 (2 pcs.)		CHF 378 (2 pcs.)		
CL.	GA	B	B				
DS.	Telaio Frame Structure Estructura Stahlrahmen		Coppia pannelli di tamponamento in melaminico bianco Pair of panels in white melaminic Paire de panneaux en mélaminé blanc Par de paneles en melamina blanca Panneele melaminbeschichtet weiss (Paar)		Coppia pannelli di tamponamento in metacrilato traslucido Pair of panels in translucent methacrylate Paire de panneaux en methacrylate translucide Par de paneles en metacrilado traslucido Panneele aus Acrylglas, weiss (Paar)		
CD.	1042-GA	1042-B		1043-GA	1043-B		
PR.	CHF 158	CHF 158		CHF 196	CHF 196		
CL.	C/GA	C/B		C/GA	C/B		
DS.	Barra portabiti cromata, supporti verniciati Chrome-plated coat rail. Epoxy-coated supports Barre porte-manteaux chromée. Supports peint en epoxy Barra porta perchas cromada. Soportes pintados Garderobestange, Stahl verchromt. Epoxypulver beschichtetem Träger			Barra portabiti cromata, supporti verniciati Chrome-plated coat rail. Epoxy-coated supports Barre porte-manteaux chromée. Supports peint en epoxy Barra porta perchas cromada. Soportes pintados Garderobestange, Stahl verchromt. Epoxypulver beschichtetem Träger			
CD.	1010	1011	1012	1013	1014		
PR.	CHF 28	CHF 56 (2 pcs.)	CHF 56 (2 pcs.)	CHF 92 (2 pcs.)	CHF 108 (2 pcs.)		
CL.							
DS.	Terminale Terminal element Élément d'extrémité Elemento final Endstück mit Stellschraube	Collegamento lineare. Linear connection Connection linéaire Connexion lineal Verbindungsstück gerade	Collegamento a L L-connection Connection à L Connexion a L Eckverbinder	Collegamento a T T-connection Connection à T Connexion a T T-verbinder	Collegamento 4 vie 4-ways connection Connection 4 voies Connexion 4 vias Kreuzverbinder		

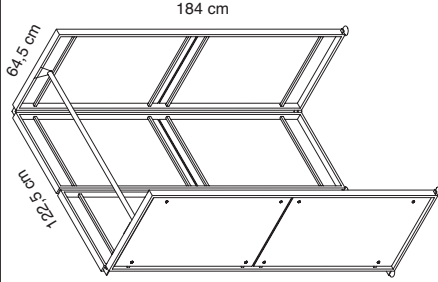

Telaio grigio argento senza pannelli
Silver grey frame without panels
Structure gris argentée sans panneaux
Estructura gris plata sin paneles
Silbergrau Stahlrahmen ohne Paneele

- 4 pcs. 1000-GA
- 1 pcs. 1042-GA
- 2 pcs. 1010
- 1 pcs. 1011
- 2 pcs. 1012

Art. 1099-C1
CHF 1486

Telaio bianco senza pannelli
White frame without panels
Structure blanche sans panneaux
Estructura blanca sin paneles
Stahlrahmen Weiss ohne Paneele

- 4 pcs. 1000-B
- 1 pcs. 1042-B
- 2 pcs. 1010
- 1 pcs. 1011
- 2 pcs. 1012

Art. 1099-C2
CHF 1486

Telaio grigio argento con pannelli in melaminico bianco
Silver grey frame with white melaminic panels
Structure gris argentée avec de panneaux en mélaminé blanc
Estructura gris plata con paneles en melamina blanca
Stahlrahmen Silbergrau mit Paneele melaminbeschichtet weiß

- 4 pcs. 1000-GA
- 4 pcs. 1020-B
- 1 pcs. 1042-GA
- 2 pcs. 1010
- 1 pcs. 1011
- 2 pcs. 1012

Art. 1099-C3
CHF 2014

Telaio bianco con pannelli in melaminico bianco
White frame with white melaminic panels
Structure blanche avec de panneaux en mélaminé blanc
Estructura blanca con paneles en melamina blanca
Stahlrahmen Weiss mit Paneele melaminbeschichtet weiß

- 4 pcs. 1000-B
- 4 pcs. 1020-B
- 1 pcs. 1042-B
- 2 pcs. 1010
- 1 pcs. 1011
- 2 pcs. 1012

Art. 1099-C4
CHF 2014

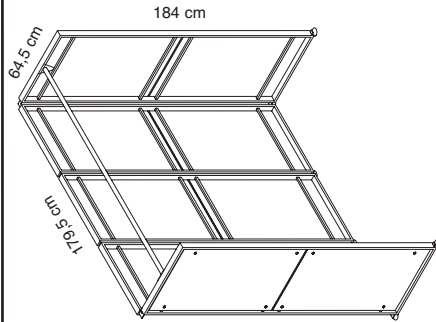

Telaio grigio argento senza pannelli
Silver grey frame without panels
Structure gris argentée sans panneaux
Estructura gris plata sin paneles
Silbergrau Stahlrahmen ohne Paneele

- 5 pcs. 1000-GA
- 1 pcs. 1043-GA
- 2 pcs. 1010
- 2 pcs. 1011
- 2 pcs. 1012

Art. 1099-C5
CHF 1856

Telaio bianco senza pannelli
White frame without panels
Structure blanche sans panneaux
Estructura blanca sin paneles
Stahlrahmen Weiss ohne Paneele

- 5 pcs. 1000-B
- 1 pcs. 1043-B
- 2 pcs. 1010
- 2 pcs. 1011
- 2 pcs. 1012

Art. 1099-C6
CHF 1856

Telaio grigio argento con pannelli in melaminico bianco
Silver grey frame with white melaminic panels
Structure gris argentée avec de panneaux en mélaminé blanc
Estructura gris plata con paneles en melamina blanca
Stahlrahmen Silbergrau mit Paneele melaminbeschichtet weiß

- 5 pcs. 1000-GA
- 5 pcs. 1020-B
- 1 pcs. 1043-GA
- 2 pcs. 1010
- 2 pcs. 1011
- 2 pcs. 1012

Art. 1099-C7
CHF 2516

Telaio bianco con pannelli in melaminico bianco
White frame with white melaminic panels
Structure blanche avec de panneaux en mélaminé blanc
Estructura blanca con paneles en melamina blanca
Stahlrahmen Weiss mit Paneele melaminbeschichtet weiß

- 5 pcs. 1000-B
- 5 pcs. 1020-B
- 1 pcs. 1043-B
- 2 pcs. 1010
- 2 pcs. 1011
- 2 pcs. 1012

Art. 1099-C8
CHF 2516

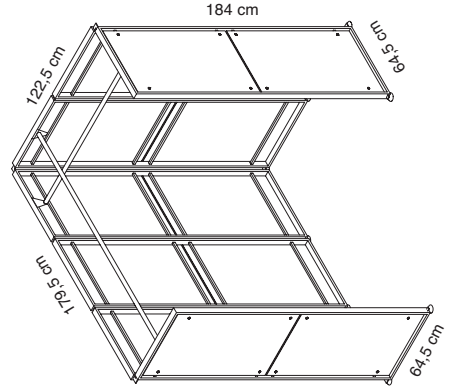

Telaio grigio argento senza pannelli
Silver grey frame without panels
Structure gris argentée sans panneaux
Estructura gris plata sin paneles
Silbergrau Stahlrahmen ohne Paneele

- 7 pcs. 1000-GA
- 1 pcs. 1042-GA
- 1 pcs. 1043-GA
- 2 pcs. 1010
- 3 pcs. 1011
- 3 pcs. 1012

Art. 1099-C9
CHF 2678

Telaio bianco senza pannelli
White frame without panels
Structure blanche sans panneaux
Estructura blanca sin paneles
Stahlrahmen Weiss ohne Paneele

- 7 pcs. 1000-B
- 1 pcs. 1042-B
- 1 pcs. 1043-B
- 2 pcs. 1010
- 3 pcs. 1011
- 3 pcs. 1012

Art. 1099-C10
CHF 2678

Telaio grigio argento con pannelli in melaminico bianco
Silver grey frame with white melaminic panels
Structure gris argentée avec de panneaux en mélaminé blanc
Estructura gris plata con paneles en melamina blanca
Stahlrahmen Silbergrau mit Paneele melaminbeschichtet weiß



- 7 pcs. 1000-GA
- 7 pcs. 1020-B
- 1 pcs. 1042-GA
- 1 pcs. 1043-GA
- 2 pcs. 1010
- 3 pcs. 1011
- 3 pcs. 1012

Art. 1099-C11
CHF 3602

Telaio bianco con pannelli in melaminico bianco
White frame with white melaminic panels
Structure blanche avec de panneaux en mélaminé blanc
Estructura blanca con paneles en melamina blanca
Stahlrahmen Weiss mit Paneele melaminbeschichtet weiß



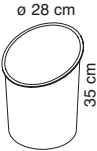

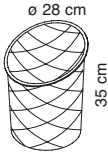
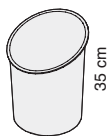
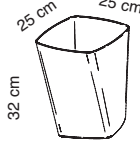
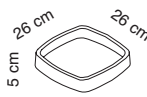
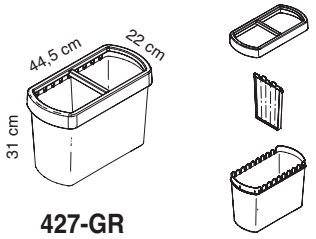
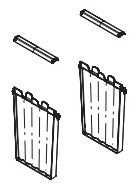
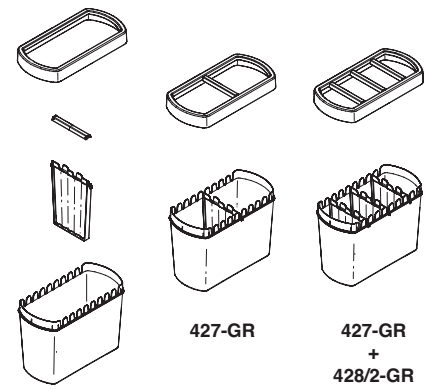
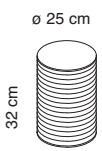
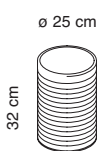
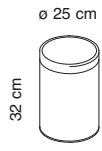
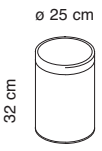
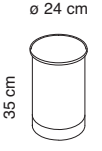

- 7 pcs. 1000-B
- 7 pcs. 1020-B
- 1 pcs. 1042-B
- 1 pcs. 1043-B
- 2 pcs. 1010
- 3 pcs. 1011
- 3 pcs. 1012

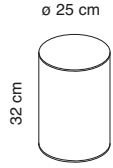
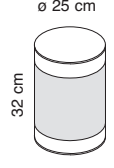
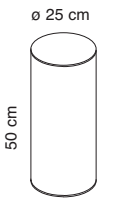
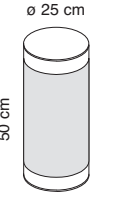

Art. 1099-C12
CHF 3602

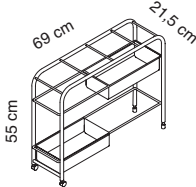

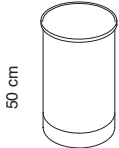
HI-TECH					
				12 L	
CD.	414	414-GR	414-BO	414-T	414-OP
PR.	CHF 32 / Stück	CHF 32 / Stück	CHF 32 / Stück	CHF 40 / Stück	CHF 40 / Stück
CD.	414M	414M-GR	414M-BO		
PR.	CHF 20 / Stück Prezzo per ordini superiori a 10 pz. Price for orders over 10 pcs. Prix pour c.des supérieures à 10 pcs. Precio para mas de 10 pzs Preis für Aufträge von über 10 Stück	CHF 24 / Stück Prezzo per ordini superiori a 10 pz. Price for orders over 10 pcs. Prix pour c.des supérieures à 10 pcs. Precio para mas de 10 pzs Preis für Aufträge von über 10 Stück	CHF 24 / Stück Prezzo per ordini superiori a 10 pz. Price for orders over 10 pcs. Prix pour c.des supérieures à 10 pcs. Precio para mas de 10 pzs Preis für Aufträge von über 10 Stück		
CL.	N	GR	BO	TB - TA	OP
DS.	Polipropilene nero Black polypropylene Polypropylène noir Polipropileno negro Schwarzem Polypropylen	Polipropilene grigio Grey polypropylene Polypropylène gris Polipropileno gris Grauem Polypropylen	Polipropilene bianco opaco Mat white polypropylene Polypropylène blanc mat Polipropileno blanco mate Mattweiß Polypropylen	Polipropilene traslucido Translucent polypropylene Polypropylène translucide Polipropileno traslúcido Lichtdurchlässigem Polypropylen	Polipropilene traslucido Translucent polypropylene Polypropylène translucide Polipropileno traslúcido Lichtdurchlässigem Polypropylen
HI-TECH					
				Reggisacchetto per articoli: 414, 414-T, 414-GR, Trash bag support for ref.: 414-GM, 414-OP, 414-BO, Support sac pour articles: 413-T, 413-TRO, 414-ECO Sujeta bolsas ref.: Müllsackhalter für:	
CD.	415	415-GR	415-BO	415-T	415-GM
PR.	CHF 16 / Stück	CHF 16 / Stück	CHF 16 / Stück	CHF 20 / Stück	CHF 35 / Stück
CD.	415M	415M-GR	415M-BO		
PR.	CHF 12 / Stück Prezzo per ordini superiori a 10 pz. Price for orders over 10 pcs. Prix pour c.des supérieures à 10 pcs. Precio para mas de 10 pzs Preis für Aufträge von über 10 Stück	CHF 13 / Stück Prezzo per ordini superiori a 10 pz. Price for orders over 10 pcs. Prix pour c.des supérieures à 10 pcs. Precio para mas de 10 pzs Preis für Aufträge von über 10 Stück	CHF 13 / Stück Prezzo per ordini superiori a 10 pz. Price for orders over 10 pcs. Prix pour c.des supérieures à 10 pcs. Precio para mas de 10 pzs Preis für Aufträge von über 10 Stück		
CL.	N	GR	BO	TB - TA	GM
DS.	Polipropilene nero Black polypropylene Polypropylène noir Polipropileno negro Schwarzem Polypropylen	Polipropilene grigio Grey polypropylene Polypropylène gris Polipropileno gris Grauem Polypropylen	Polipropilene bianco opaco Mat white polypropylene Polypropylène blanc mat Polipropileno blanco mate Mattweiß Polypropylen	Polipropilene traslucido Translucent polypropylene Polypropylène translucide Polipropileno traslúcido Lichtdurchlässigem Polypropylen	Tecnopolimero verniciato Painted high-tech polymer Techno-polymère peint Tecnopolimero barnizado Beschichtetem Technopolymer

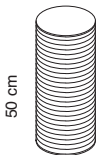
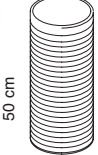
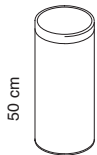
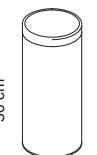

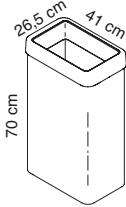
	CESTO 12 L 		HI-TECH 12 L 		SWING 13,5 L 		SWING 									
CD.	413-T		413-TRO		414-ECO		421-N		421-B		422-N		422-B			
PR.	CHF 59		CHF 59		CHF 39		CHF 48		CHF 48		CHF 26		CHF 26			
CL.	T		TRO				N		B		N		B			
DS.	Policarbonato trasparente o rosso trasparente. Transparent or transparent red polycarbonate. Polycarbonate transparent ou rouge transparent Policarbonato transparente o rojo transparente Polykarbonat, weiss oder rot transparent				Fibra di legno riciclata e polipropilene Recycled wood fibre and polypropylene Fibre de bois recyclée et polypropylène Fibra de madera reciclada y polipropileno Recyclete Holzfasern und Polypropylen				Tecnopolimero nero Black high-tech polymer Technopolymère noir Tecnopolimero negro Polymer schwarz		Tecnopolimero bianco White high-tech polymer Technopolymère blanc Tecnopolimero blanco Polymer weiss		Reggisacchetto per articoli: Trash bag inner support for ref.: Support sac pour articles: Sujeta bolsas ref.: Müllsackhalter für: 421-N - 421-B			
	DIVIDO 				DIVIDO 		Opzionali Optional		5 etichette per colore (tot. 25) 5 labels per colour (tot. 25) 5 étiquettes pour couleur (tot. 25) 5 etiquetas para colore (tot. 25) 5 Etiketten pro Farbe (tot. 25)		SCHEMA DI MONTAGGIO 					
CD.	427-GR				428/2-GR				429							
PR.	CHF 71				CHF 34 (2 pcs.)				CHF 20							
CL.	GR				GR											
DS.	Tecnopolimero grigio. Completo di 1 divisorio Grey high-tech polymer, equipped with 1 partition Technopolymère gris, avec un séparateur Tecnopolimero gris, 1 separador Graues Polymer. 1 Trennelement inbegriffen				2 divisori in tecnopolimero grigio Set of 2 grey high-tech polymer partitions Jeu de 2 séparateurs en Technopolymère gris 2 separadores en tecnopolimero gris 2 Trennelemente aus grauem Polymer				Etichette in 5 colori per art. DIVIDO Set of labels 5 colours DIVIDO Jeu d'étiquettes 5 couleurs pour DIVIDO Set de etiquetas 5 colores para DIVIDO Selbstklebeetiketten 5 Farben für DIVIDO		427-GR 427-GR + 428/2-GR					
	DESIGN COLLECTION 14 L 		DESIGN COLLECTION 14 L 		MASTER 14 L 		MASTER 14 L 		HI-TECH 13 L ø 24 cm 		Antincendio Fire-resistant Anti-feu Antincendio Feuerfeste					
CD.	411-NG		417-GA		417		417-CU		417-I		402-N		402-GA			
PR.	CHF 124		CHF 172		CHF 183		CHF 183		CHF 179		CHF 99		CHF 99			
CL.	N		GA		N		CU		I		N		GA			
DS.	Espanso rigato nero Black ribbed polyurethane foam Polyuréthane rayé noir Expandido rayado negro Gerippter, schwarzer Schaumstoff		Espanso rigato grigio Grey ribbed polyurethane foam Polyuréthane rayé gris Expandido rayado gris Gerippter, grauer Schaumstoff		Pelle Ecologica Ecological leather Cuir écologique Piel ecologica Lederimitation		Pelle Ecologica Ecological leather Cuir écologique Piel ecologica Lederimitation		Inox Stainless steel Inox Inoxidable Rostfreier Edelstahl		Acciaio verniciato con polveri epossidiche Powder-coated steel Acier peint en époxy Acero pintado con polvos epoxi Stahl mit Epoxypulver-Beschichtung					

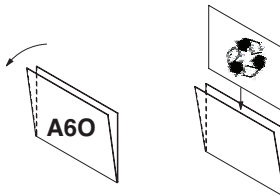
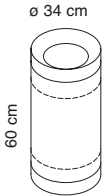
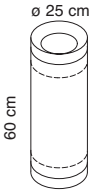
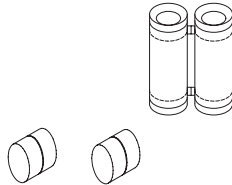

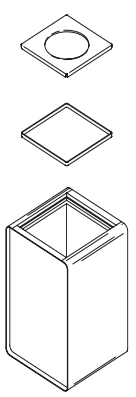
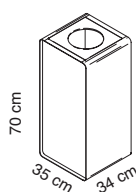
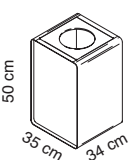
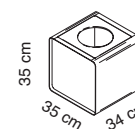
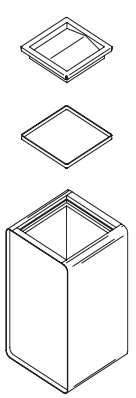
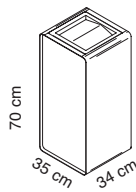
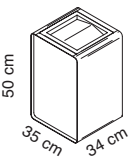
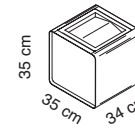
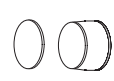
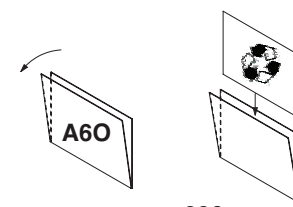

	HI-TECH		14 L	HI-TECH		14 L
CD.	411-N		411-GA	412-F		412-GAF
PR.	CHF 71 / Stück		CHF 71 / Stück	CHF 85 / Stück		CHF 85 / Stück
CD.	411M-N		411M-GA	412M-F		412M-GAF
PR.	CHF 56 / Stück Prezzo per ordini superiori a 8 pz. Price for orders over 8 pcs. Prix pour c.des supérieures à 8 pcs. Precio para mas de 8 pzs Preis für Aufträge von über 8 Stück		CHF 56 / Stück Prezzo per ordini superiori a 8 pz. Price for orders over 8 pcs. Prix pour c.des supérieures à 8 pcs. Precio para mas de 8 pzs Preis für Aufträge von über 8 Stück	CHF 60 / Stück Prezzo per ordini superiori a 8 pz. Price for orders over 8 pcs. Prix pour c.des supérieures à 8 pcs. Precio para mas de 8 pzs Preis für Aufträge von über 8 Stück		CHF 60 / Stück Prezzo per ordini superiori a 8 pz. Price for orders over 8 pcs. Prix pour c.des supérieures à 8 pcs. Precio para mas de 8 pzs Preis für Aufträge von über 8 Stück
CL.	N		GA	N		GA
DS.	Fusto e base neri Black drum and base Fût et base noirs Cilindro y base negros Gehäuse und Boden schwarz		Fusto e base grigio metallizzato Metal grey drum and base Fût et base gris métalisé Cilindro y base gris metal Gehäuse und Boden silbergrau	Fusto e base neri Black drum and base Fût et base noirs Cilindro y base negros Gehäuse und Boden schwarz		Fusto e base grigio metallizzato Metal grey drum and base Fût et base gris métalisé Cilindro y base gris metal Gehäuse und Boden silbergrau
	HI-TECH		22 L	HI-TECH		22 L
CD.	506-N		506-GA	506-F		506-GAF
PR.	CHF 124 / Stück		CHF 124 / Stück	CHF 148 / Stück		CHF 148 / Stück
CD.	506M-N		506M-GA	506M-F		506M-GAF
PR.	CHF 84 / Stück Prezzo per ordini superiori a 6 pz. Price for orders over 6 pcs. Prix pour c.des supérieures à 6 pcs. Precio para mas de 6 pzs Preis für Aufträge von über 6 Stück		CHF 84 / Stück Prezzo per ordini superiori a 6 pz. Price for orders over 6 pcs. Prix pour c.des supérieures à 6 pcs. Precio para mas de 6 pzs Preis für Aufträge von über 6 Stück	CHF 106 / Stück Prezzo per ordini superiori a 6 pz. Price for orders over 6 pcs. Prix pour c.des supérieures à 6 pcs. Precio para mas de 6 pzs Preis für Aufträge von über 6 Stück		CHF 106 / Stück Prezzo per ordini superiori a 6 pz. Price for orders over 6 pcs. Prix pour c.des supérieures à 6 pcs. Precio para mas de 6 pzs Preis für Aufträge von über 6 Stück
CL.	N		GA	N		GA
DS.	Fusto e base neri Black drum and base Fût et base noirs Cilindro y base negros Gehäuse und Boden schwarz		Fusto e base grigio metallizzato Metal grey drum and base Fût et base gris métalisé Cilindro y base gris metal Gehäuse und Boden silbergrau	Fusto e base neri Black drum and base Fût et base noirs Cilindro y base negros Gehäuse und Boden schwarz		Fusto e base grigio metallizzato Metal grey drum and base Fût et base gris métalisé Cilindro y base gris metal Gehäuse und Boden silbergrau

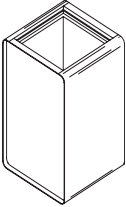
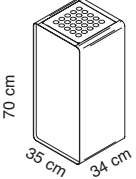
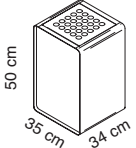
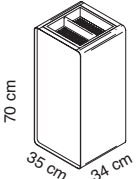
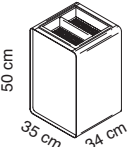
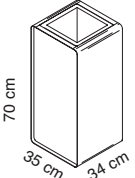
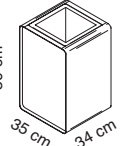
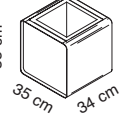

	HI-TECH		HI-TECH		PIOGGIA				
									
CD.	418	418-GR	419	419-T	510-GA				
PR.	CHF 15	CHF 15	CHF 16	CHF 16	CHF 298				
CL.	N	GR	N	TB - TA	GA				
DS.	Reggisacchetto per articoli: 411-N, 411-GA, 411-NG, 412-F, 412-GAF Trash bag inner support for ref.: 411-N, 411-GA, 411-NG, 412-F, 412-GAF Support sac pour articles: 411-N, 411-GA, 411-NG, 412-F, 412-GAF Sujeta bolsas ref.: 411-N, 411-GA, 411-NG, 412-F, 412-GAF Müllsackhalter für: 411-N, 411-GA, 411-NG, 412-F, 412-GAF							Portaombrelli a rastrelliera in acciaio Steel umbrella-rack Porte-parapluies à râtelier en acier Paragüero con soportes de acero Schirmständer-Gestell aus Stahl	
	HI-TECH		HI-TECH		HI-TECH				
			43 L Antincendio Fire-resistant Anti-feu Antincendio Feuerfeste					18,5 L Antincendio Fire-resistant Anti-feu Antincendio Feuerfest	
CD.	416		416-GA		496-N		496-GA		
PR.	CHF 246		CHF 246		CHF 150		CHF 150		
CL.	N		GA		N		GA		
DS.	Acciaio verniciato con polveri epossidiche Powder-coated steel Acier peint en époxy Acero pintado con polvos epoxi Stahl mit Epoxypulver-Beschichtung				Acciaio verniciato con polveri epossidiche Powder-coated steel Acier peint en époxy Acero pintado con polvos epoxi Stahl mit Epoxypulver-Beschichtung				
	DESIGN COLLECTION		DESIGN COLLECTION		MASTER		MASTER		
									
CD.	505-NG		507-GA		507		507-I		
PR.	CHF 197		CHF 207		CHF 222		CHF 207		
CL.	N		GA		N		I		
DS.	Espanso rigato nero Black ribbed polyurethane foam Polyuréthane rayé noir Expandido rayado negro Gerippter, schwarzer Schaumstoff		Espanso rigato grigio Grey ribbed polyurethane foam Polyuréthane rayé gris Expandido rayado gris Gerippter, grauer Schaumstoff		Pelle ecologica Ecological leather Cuir écologique Piel ecologica Lederimitation		Inox Stainless steel Inox Inoxidable Rostfreier Edelstahl		

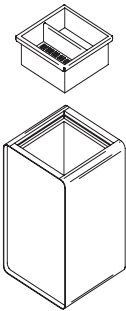
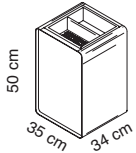
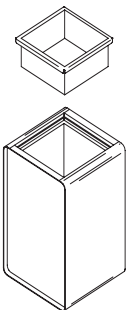
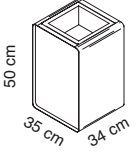

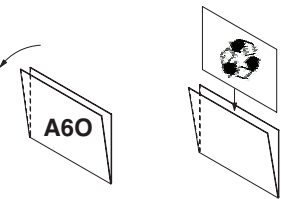
	MAXI				
				70 L	Fusto grigio argento Silver grey drum Fût gris argenté Cilindro gris plata Gehäuse silbergrau
CD.	360-GAGR	360-GAR	360-GAVE	360-GABL	360-GAGL
PR.	CHF 316	CHF 316	CHF 316	CHF 316	CHF 316
CL.	GR	R	VE	BL	GL
DS.	Fusto verniciato. Top grigio Powder-coated drum. Grey top Fût époxy. Top gris Cilindro pintado. Top gris Beschichtetes Gehäuse. Aufsatz graugrau	Fusto verniciato. Top rosso Powder-coated drum. Red top Fût époxy. Top rouge Cilindro pintado. Top rojo Beschichtetes Gehäuse. Aufsatz rot	Fusto verniciato. Top verde Powder-coated drum. Green top Fût époxy. Top vert Cilindro pintado. Top verde Beschichtetes Gehäuse. Aufsatz grün	Fusto verniciato. Top blu Powder-coated drum. Blue top Fût époxy. Top bleu Cilindro pintado. Top azul Beschichtetes Gehäuse. Aufsatz blau	Fusto verniciato. Top giallo Powder-coated drum. Yellow top Fût époxy. Top jaune Cilindro pintado. Top amarillo Beschichtetes Gehäuse. Aufsatz gelb
CD.	  379			 236	
PR.	CHF 25			CHF 56	
CL.					
DS.	Foglio di etichette applicabili agli art. BROS, MAXI e PRISMA (6 pz. per ogni simbolo) Set of labels for BROS, MAXI and PRISMA (6 pieces for each symbol) Jeu d'étiquettes pour BROS, MAXI et PRISMA (6 pièces pour chaque symbole) Set de etiquetas para BROS, MAXI y PRISMA (6 pzas. por cada simbolo) Selbstklebeetiketten für BROS, MAXI und PRISMA (6 Stk. je Symbol)			Espositore a busta con biadesivo applicabile agli art. MAXI e PRISMA Envelope display-unit with double-sided tape for MAXI and PRISMA Présentoir pochette avec ruban biadhésif pour MAXI et PRISMA Expositor con puertas tipo sobre con adhesivo de doble cara para MAXI et PRISMA Einschubfach mit zweiseitig für MAXI und PRISMA	
CD.	BROS		BROS		BROS
					
CD.	372-GA	372-I	375-GA	380-GM	
PR.	CHF 320	CHF 439	CHF 247	CHF 31 (2 pcs.)	
CL.	GA	I	GA	GA	
DS.	Fusto verniciato Powder-coated drum Fût époxy Cilindro pintado Beschichtetes Gehäuse	Fusto in acciaio inox Stainless steel drum Fût en acier inox Cilindro en acero inox Rostfreier Edelstahl	Fusto Verniciato Powder-coated drum Fût époxy Cilindro pintado Beschichtetes Gehäuse	Coppia giunti collegamento cestini. Per cod.: Set of 2 connecting joints for codes: Jeu de 2 pièces de jonction pour codes: Jgo. 2 pzas. de juntas para papeleras ref. Verbindungspaar für Papierkorb. Für Art: 372-GA / 372-I / 375-GA	

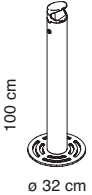
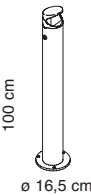

<p>CD.</p> 	<p>Per interni Indoor use</p>  <p>80 L</p>	<p>Per esterni Outdoor use</p>  <p>57 L</p>	<p>Per interni Indoor use</p>  <p>40 L</p>	
	<p>217-I</p> <p>CHF 602</p> <p>Indoor (AISI 430)</p>	<p>217-IO</p> <p>CHF 785</p> <p>Outdoor (AISI 304)</p>	<p>215-I</p> <p>CHF 588</p> <p>Indoor (AISI 430)</p>	<p>215-IO</p> <p>CHF 763</p> <p>Outdoor (AISI 304)</p>
	<p>213-I</p> <p>CHF 574</p> <p>Indoor (AISI 430)</p>			
	<p>DS.</p> <p>Cestino gettacarte in acciaio inox Stainless steel waste paper basket Corbeille à papier en acier inoxydable Papelera de acero inoxidable Papierkorb aus Edelstahl</p>			
<p>CD.</p> 	<p>Per interni Indoor use</p>  <p>80 L</p>	<p>Per interni Indoor use</p>  <p>57 L</p>	<p>Per interni Indoor use</p>  <p>40 L</p>	
	<p>227-I</p> <p>CHF 710</p> <p>Indoor (AISI 430)</p>	<p>227-IO</p> <p>CHF 891</p> <p>Outdoor (AISI 304)</p>	<p>225-I</p> <p>CHF 696</p> <p>Indoor (AISI 430)</p>	<p>225-IO</p> <p>CHF 869</p> <p>Outdoor (AISI 304)</p>
	<p>223-I</p> <p>CHF 682</p> <p>Indoor (AISI 430)</p>			
	<p>DS.</p> <p>Cestino gettacarte in acciaio inox con coperchio basculante a perno centrale Stainless steel waste paper basket with central-pin up-and-over Corbeille à papier en acier inoxydable avec pivot central Papelera de acero inoxidable con oscilante de perno central Papierkorb aus Edelstahl mit Kippöffnung mit mittlerem Drehstift</p>			
<p>CD.</p>  <p>Per interni e esterni Indoor and outdoor use</p>	<p>201-I</p> <p>CHF 61 (4 pcs.)</p>	<p>Per interni Indoor use</p>  <p>236</p> <p>CHF 56</p> <p>Indoor</p>	 <p>379</p> <p>CHF 25</p>	
	<p>DS.</p> <p>4 giunti per unione fusti 4 joints for drums connection 4 joints pour union des fûts 4 juntas para la unión de los fustes 4 Verbindungen um die Behälter zu verbinden</p> <p>Espositore a busta con biadesivo applicabile agli art. MAXI e PRISMA Envelope display-unit with double-sided tape for MAXI and PRISMA Présentoir pochette avec ruban biadhésif pour MAXI et PRISMA Expositor con puertas tipo sobre con adhesivo de doble cara para MAXI et PRISMA Einschubfach mit zweiseitig für MAXI und PRISMA</p> <p>Foglio di etichette applicabili agli art. BROS, MAXI e PRISMA (6 pz. per ogni simbolo) Set of labels for BROS, MAXI and PRISMA (6 pieces for each symbol) Jeu d'étiquettes pour BROS, MAXI et PRISMA (6 pièces pour chaque symbole) Set de etiquetas para BROS, MAXI y PRISMA (6 pzas. por cada simbolo) Selbstklebeetiketten für BROS, MAXI und PRISMA (6 Stk. Je Symbol)</p>			
	<p>Indoor = per interni, pour intérieur, para interior, für Innenbereich / Outdoor = per esterni, pour extérieur, al aire libre, für Außenbereich</p>			

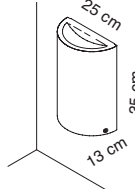
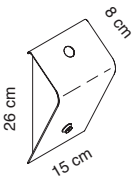
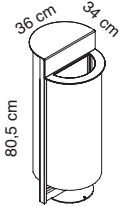
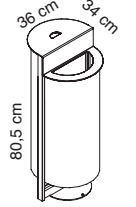

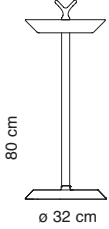
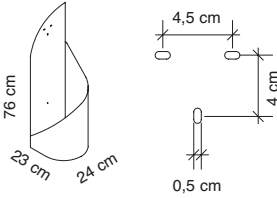
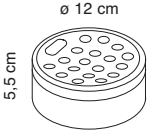
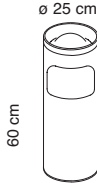
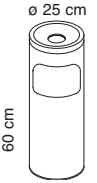
<p>CD.</p>  <p>PR.</p>  <p>CL.</p>  <p>DS.</p>	<p>Per interni Indoor use</p>  <p>247-I</p> <p>CHF 729</p> <p>Indoor (AISI 430)</p>	<p>Per esterni Outdoor use</p> <p>247-IO</p> <p>CHF 872</p> <p>Outdoor (AISI 304)</p>	<p>Per interni Indoor use</p>  <p>245-I</p> <p>CHF 714</p> <p>Indoor (AISI 430)</p>	<p>Per esterni Outdoor use</p> <p>245-IO</p> <p>CHF 866</p> <p>Outdoor (AISI 304)</p>	<p>Posacenere in acciaio inox Stainless steel ashtray Cendrier en acier inoxydable Cenicero de acero inoxidable Aschenbecher aus Edelstahl</p>			
	<p>Per interni Indoor use</p>  <p>237-I</p> <p>CHF 729</p> <p>Indoor (AISI 430)</p>	<p>Per esterni Outdoor use</p> <p>237-IO</p> <p>CHF 872</p> <p>Outdoor (AISI 304)</p>	<p>Per interni Indoor use</p>  <p>235-I</p> <p>CHF 714</p> <p>Indoor (AISI 430)</p>	<p>Per esterni Outdoor use</p> <p>235-IO</p> <p>CHF 866</p> <p>Outdoor (AISI 304)</p>		<p>Posacenere in acciaio inox con setaccio asportabile Stainless steel ashtray with removable sifter Cendrier en acier inoxydable avec tamis amovible Cenicero de acero inoxidable con criba extraible Aschenbecher aus Edelstahl mit herausnehmbarem Sieb</p>		
	<p>Per interni Indoor use</p>  <p>277-I</p> <p>CHF 745</p> <p>Indoor (AISI 430)</p>	<p>Per esterni Outdoor use</p> <p>277-IO</p> <p>CHF 901</p> <p>Outdoor (AISI 304)</p>	<p>Per interni Indoor use</p>  <p>275-I</p> <p>CHF 731</p> <p>Indoor (AISI 430)</p>	<p>Per esterni Outdoor use</p> <p>275-IO</p> <p>CHF 866</p> <p>Outdoor (AISI 304)</p>			<p>Per interni Indoor use</p>  <p>273-I</p> <p>CHF 714</p> <p>Indoor (AISI 430)</p>	<p>Fioriera in acciaio inox Stainless steel flower box Jardinière en acier inoxydable Macetas de acero inoxidable Blumentöpfe aus Edelstahl</p>
	<p>Indoor = per interni, pour intérieur, para interior, für Innenbereich / Outdoor = per esterni, pour extérieur, al aire libre, für Außenbereich</p>							

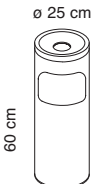
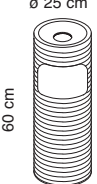
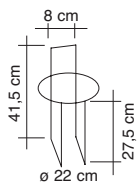
<p>CD.</p> <p>PR.</p> <p>CL.</p> <p>DS.</p>		<p>Per interni Indoor use</p>		<p>Per esterni Outdoor use</p>
		<p>265-I</p>	<p>265-IO</p>	
		<p>CHF 749</p>	<p>CHF 907</p>	
		<p>Indoor (AISI 430)</p>	<p>Outdoor (AISI 304)</p>	
<p>Portaombrelli in acciaio inox con vaschetta per ombrellini pieghevoli Stainless steel umbrella stand with tray for folding umbrellas Porte-parapluies en acier inoxydable avec bac pour parapluies pliables Paragüeros de acero inoxidable con cubeta para paraguas plegables Schirmständer aus Edelstahl mit Wanne für Knirpse</p>				
<p>CD.</p> <p>PR.</p> <p>CL.</p> <p>DS.</p>		<p>Per interni Indoor use</p>		<p>Per esterni Outdoor use</p>
		<p>255-I</p>	<p>255-IO</p>	
		<p>CHF 688</p>	<p>CHF 851</p>	
		<p>Indoor (AISI 430)</p>	<p>Outdoor (AISI 304)</p>	
<p>Portaombrelli in acciaio inox Stainless steel umbrella stand Porte-parapluies en acier inoxydable Paragüeros de acero inoxidable Schirmständer aus Edelstahl</p>				
<p>CD.</p> <p>PR.</p> <p>CL.</p> <p>DS.</p>		<p>Per interni e esterni Indoor and outdoor use</p>		<p>Per interni Indoor use</p>
	<p>201-I</p>	<p>236</p>		
	<p>CHF 61 (4 pcs.)</p>	<p>CHF 56</p>	<p>CHF 25</p>	
	<p>Indoor</p>	<p>Indoor</p>	<p>Indoor</p>	
<p>4 giunti per unione fusti 4 joints for drums connection 4 joints pour union des fûts 4 juntas para la unión de los fustes 4 Verbindungen um die Behälter zu verbinden</p>				
<p>Espositore a busta con biadesivo applicabile agli art. MAXI e PRISMA Envelope display-unit with double-sided tape for MAXI and PRISMA Présentoir pochette avec ruban biadhésif pour MAXI et PRISMA Expositor con puertas tipo sobre con adhesivo de doble cara para MAXI et PRISMA Einschubfach mit zweiseitig für MAXI und PRISMA</p>				
<p>Foglio di etichette applicabili agli art. BROS, MAXI e PRISMA (6 pz. per ogni simbolo) Set of labels for BROS, MAXI and PRISMA (6 pieces for each symbol) Jeu d'étiquettes pour BROS, MAXI et PRISMA (6 pièces pour chaque symbole) Set de etiquetas para BROS, MAXI y PRISMA (6 pzas. por cada símbolo) Selbstklebeetiketten für BROS, MAXI und PRISMA (6 Stk. Je Symbol)</p>				
<p>Indoor = per interni, pour intérieur, para interior, für Innenbereich / Outdoor = per esterni, pour extérieur, al aire libre, für Außenbereich</p>				

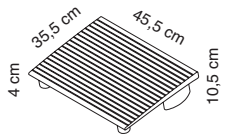
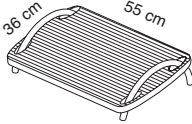
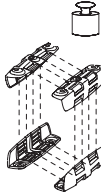
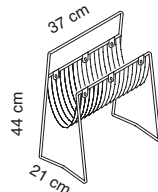
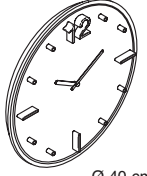
<p>CD.</p>	<p>ESTERNO</p>  <p>Anche per uso esterno Also for outdoor use Utilisable aussi à l'extérieur Tambien para exterior Auch für Aussenanwendung</p> <p>307-NM</p>	<p>ESTERNO</p>  <p>Anche per uso esterno Also for outdoor use Utilisable aussi à l'extérieur Tambien para exterior Auch für Aussenanwendung</p> <p>305-NM</p>	<p>ESTERNO</p>  <p>Anche per uso esterno Also for outdoor use Utilisable aussi à l'extérieur Tambien para exterior Auch für Aussenanwendung</p> <p>303-NM</p>
<p>PR.</p>	<p>CHF 558</p>	<p>CHF 536</p>	<p>CHF 396</p>
<p>CL.</p>	<p>NM</p>	<p>NM</p>	<p>NM</p>
<p>DS.</p>	<p>Posacenere in alluminio per esterni con base autoportante in acciaio. Outdoor aluminium ashtray with free-standing steel base Cendrier pour l'extérieur en aluminium avec base autoportante en acier Cenicero en aluminio para exterior con base auto-portante de acero Aschenbecher aus Aluminium für Aussenanwendung, mit selbsttragender Basis aus Stahl</p>	<p>Posacenere in alluminio per esterni con base per fissaggio a terra in acciaio. Outdoor aluminium ashtray with floor-fixing steel base Cendrier pour l'extérieur en aluminium avec base en acier pour fixation au sol Cenicero en aluminio para exterior con base de acero para la sujeción al suelo Aschenbecher aus Aluminium für Aussenanwendung, mit Basis aus Stahl zur Befestigung am Boden</p>	<p>Posacenere in alluminio per esterni con fissaggio a parete in acciaio. Outdoor aluminium ashtray with wall-fixing steel fastening Cendrier pour l'extérieur en aluminium avec fixation au mur en acier Cenicero en aluminio para exterior con sujeción a pared de acero Aschenbecher aus Aluminium für Aussenanwendung, mit Wandbefestigung aus Stahl</p>
<p>CD.</p>	<p>SMILE</p>  <p>Anche per uso esterno Also for outdoor use Utilisable aussi à l'extérieur Tambien para exterior Auch für Aussenanwendung</p> <p>430-I</p>	<p>PIAZZA</p>  <p>Anche per uso esterno Also for outdoor use Utilisable aussi à l'extérieur Tambien para exterior Auch für Aussenanwendung</p> <p>435-I</p>	
<p>PR.</p>	<p>CHF 491</p>	<p>CHF 427</p>	
<p>CL.</p>	<p>I</p>	<p>I</p>	
<p>DS.</p>	<p>Acciaio Inox AISI 304 Stainless steel AISI 304 Acier inox AISI 304 Acero inox AISI 304 Rostfreier Edelstahl AISI 304</p>	<p>Acciaio Inox AISI 304 Stainless steel AISI 304 Acier inox AISI 304 Acero inox AISI 304 Rostfreier Edelstahl AISI 304</p>	
<p>CD.</p>	<p>TORRE Da fissare al suolo To be fixed to the ground A fixer au sol Fijar al suelo Zur Bodenbefestigung</p>  <p>Anche per uso esterno Also for outdoor use Utilisable aussi à l'extérieur Tambien para exterior Auch für Aussenanwendung</p> <p>450-I</p>	<p>TORRE Da fissare al suolo To be fixed to the ground A fixer au sol Fijar al suelo Zur Bodenbefestigung</p>  <p>Anche per uso esterno Also for outdoor use Utilisable aussi à l'extérieur Tambien para exterior Auch für Aussenanwendung</p> <p>451-I</p>	
<p>PR.</p>	<p>CHF 1379</p>	<p>CHF 1397</p>	
<p>CL.</p>	<p>I</p>	<p>I</p>	
<p>DS.</p>	<p>Acciaio Inox AISI 304 Stainless steel AISI 304 Acier inox AISI 304 Acero inox AISI 304 Rostfreier Edelstahl AISI 304</p>	<p>Acciaio Inox AISI 304 Stainless steel AISI 304 Acier inox AISI 304 Acero inox AISI 304 Rostfreier Edelstahl AISI 304</p>	

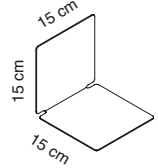
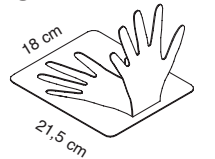
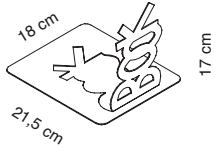
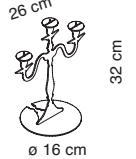
<p>BATTISTA</p>  <p>Anche per uso esterno Also for outdoor use Utilisable aussi à l'extérieur Tambien para exterior Auch für Aussenanwendung</p> <p>CD. 1693-NM</p>	<p>GRISU'</p>  <p>Viti e attacco estintore non inclusi Screws and extinguisher support not included Vis et support pour extincteur pas inclus Tornillos y soporte para extintor no incluidos Schraube und Befestigung für Feuerlöscher nicht enthalten</p> <p>CD. 523-GA</p>			
<p>PR. CHF 396</p>	<p>PR. CHF 355</p>			
<p>CL. NM</p>	<p>CL. GA</p>			
<p>DS. Posacenere / portaoggetti Ashtray / Objects holder Cendrier / Porte-objets Cenicero / Portaobjetos Aschenbecher / Behälter</p>	<p>DS. Acciaio zincato e verniciato. Testato TUV Zinc-coated and epoxy painted steel. TUV tested Acier galvanisé et peint époxy. Testé TUV Acero zincado y recubierto con polvo epoxy. Testado TUV Verzinkter Stahl, mit Epoxypulver beschichtet, TÜV getestet</p>			
<p>HI-TECH / STOP-N</p>  <p>CD. 106-N</p>	<p>SERIE 5A</p>  <p>CD. 393-SPN</p>	<p>SERIE 5A</p>  <p>CD. 394-GA</p>		
<p>PR. CHF 22</p>	<p>PR. CHF 148</p>	<p>PR. CHF 148</p>	<p>PR. CHF 210</p>	<p>PR. CHF 210</p>
<p>CL. N - GM</p>	<p>CL. N</p>	<p>CL. GA</p>	<p>CL. N</p>	<p>CL. GA</p>
<p>DS. Coperchio nero Black top Couvercle noir Tapa negra Schwarzer Deckel</p>	<p>DS. Fusto Verniciato Powder-coated drum Fût époxy Cilindro pintado Beschichtetes Gehäuse</p>	<p>DS. Coperchio cromato Chrome-plated top Couvercle chromé Tapa cromada Verchromter Deckel</p>		
<p>SERIE 5A</p>  <p>CD. 392-I</p>	<p>SERIE 5A</p>  <p>CD. 393-I</p>	<p>DESIGN COLLECTION</p>  <p>CD. 393-GA</p>	<p>SERIE 5A</p>  <p>CD. 472</p>	
<p>PR. CHF 320</p>	<p>PR. CHF 309</p>	<p>PR. CHF 308</p>	<p>PR. CHF 66</p>	
<p>CL. I</p>	<p>CL. I</p>	<p>CL. GA</p>	<p>CL. N</p>	
<p>DS. Fusto e coperchio Inox Stainless steel drum and top Fût et couvercle inox Cilindro y tapa inox Gehäuse und Deckel aus rostfreiem Edelstahl</p>	<p>DS. Fusto Inox Stainless steel drum Fût inox Cilindro inox Gehäuse aus rostfreiem Edelstahl</p>	<p>DS. Espanso rigato grigio Grey ribbed polyurethane foam Polyuréthane rayé gris Expandido rayado gris Gerippter, grauer Schaumstoff</p>	<p>DS. Reggisacchetto per articoli: Trash bag inner support for ref.: Support sac pour articles: Sujeta bolsas ref.: Müllsackhalter für: 393, 394-GA, 393-GA 393-SPN, 393-SPNGA, 393-I</p>	

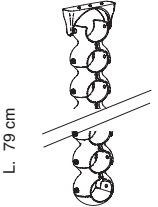
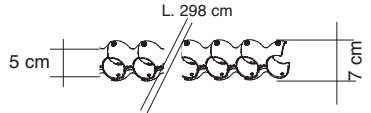
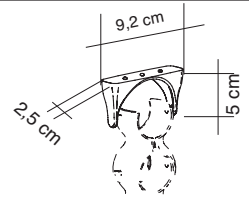

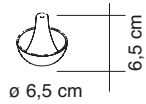
<p>ISOLE Conforme al D.L. 626</p>  <p>CD. 336</p>	<p>ISOLE Conforme al D.L. 626</p>  <p>Inclinazione 0 ÷ 20° CD. 337</p>	<p>BELT</p>  <p>Portata massima 10 Kg Maximum load 10 Kg CD. 7950</p>	<p>STIL</p>  <p>CD. 545-GA</p>				
<p>PR. CHF 125</p>	<p>PR. CHF 180</p>	<p>PR. CHF 131</p>	<p>PR. CHF 143</p>				
<p>CL. GS</p>	<p>CL. GS</p>	<p>CL. GR</p>	<p>CL. GA</p>				
<p>DS. Poggiapiedi Foot-rest Repose-pied Reposapiés Fußstütze</p>	<p>DS. Poggiapiedi regolabile Adjustable foot-rest Repose-pied réglable Reposapiés regulable Einstellbare Fussstütze</p>	<p>DS. Porta CPU in tecnopolimero grigio Grey high-tech polymer CPU cradle Porte CPU en polymère gris Porta CPU en tecnopolimero gris CPU-Halterung Kunststoff grau</p>	<p>DS. Espanso rigato grigio - struttura grigio argento Grey ribbed polyur. foam - silver grey frame Polyuréthane rayé gris - estructura gris argenté Expandido rayado gris - estructura gris plata Gerippter, grauer Schaumstoff - Gestell silbergrau</p>				
<p>OREDODICI</p>  <p>Ø 40 cm</p> <p>CD. 1472-NB</p>				<p>OREDODICI</p>  <p>Ø 40 cm</p> <p>CD. 1472-ECO</p>			
<p>PR. CHF 106</p>	<p>PR. CHF 122</p>	<p>PR. CHF 122</p>	<p>PR. CHF 122</p>	<p>PR. CHF 140</p>			
<p>CL. N</p>	<p>CL. B</p>	<p>CL. N</p>	<p>CL. GA</p>	<p>CL.</p>			
<p>DS. Orologio nero – numeri bianchi Black clock – white numbers Horloge noir – chiffres blancs Reloj negro – números blancos Schwarze Uhr – weisse Nummern</p>	<p>DS. Orologio bianco – numeri neri White clock – black numbers Horloge blanc – chiffres noirs Reloj blanco – números negros Weisse Uhr – schwarze Nummern</p>	<p>DS. Orologio nero – numeri bianchi/rossi Black clock – white/red numbers Horloge noir - chiffres blancs/rouges Reloj negro – números blancos/rojos Schwarze Uhr – weisse/rote Nummern</p>	<p>DS. Orologio grigio argento Silver grey clock Horloge gris argenté Reloj gris plata Silbergrau Uhr</p>	<p>DS. Orologio in fibra di legno riciclata e polipropilene Clock in recycled wood fibre and polypropylene Horloge en fibre de bois recyclée et polypropylène Reloj en fibra de madera reciclada y polipropileno Uhr aus recycelter Holzfaser und Polypropylen</p>			
<p>STOPPER/BIG</p>  <p>CD. 5987-GA</p>		<p>MANO</p>  <p>CD. 1420-BO</p>		<p>BOOK</p>  <p>CD. 1421-BO</p>	<p>MARIE ANTOINETTE</p>  <p>Ø 16 cm CD. 1423-BO *</p>		
<p>PR. CHF 49 (2 pcs.)</p>	<p>PR. CHF 49 (2 pcs.)</p>	<p>PR. CHF 49 (2 pcs.)</p>	<p>PR. CHF 74 (2 pcs.)</p>	<p>PR. CHF 74 (2 pcs.)</p>	<p>PR. CHF 143</p>		
<p>CL. GA</p>	<p>CL. BO</p>	<p>CL. N</p>	<p>CL. BO</p>	<p>CL. BO</p>	<p>CL. BO</p>		
<p>DS. Fermalibri in acciaio verniciato Powder-coated steel book holder Serre-livres en acier peint Separadores en acero barnizado Buchstütze aus beschichtetem Stahl</p>					<p>DS. Candelabro in acciaio verniciato Powder-coated steel candelabrum Candélabre en acier peint Candelabro en acero pintado Kerzenständer aus beschichtetem Stahl</p>		
<p>(*) Disponibile fino ad esaurimento scorte - (*) Available until selling out - (*) Disponible jusqu'à l'épuisement du stock - (*) Disponible hasta agotamiento de las reservas - (*) Solange der Vorrat reicht</p>							



	BISS			BISS			
							
CD.	1740-BO	1740-GR	1740-T	1742-BO	1742-GR	1742-T	
PR.	CHF 75 / Stück	CHF 75 / Stück	CHF 76 / Stück	CHF 198 / Stück	CHF 198 / Stück	CHF 199 / Stück	
CD.	1740M-BO	1740M-GR	1740M-T	1742M-BO	1742M-GR	1742M-T	
PR.	CHF 55 / Stück	CHF 55 / Stück	CHF 56 / Stück	CHF 171 / Stück	CHF 171 / Stück	CHF 172 / Stück	
	Prezzo per ordini superiori a 6 pz. Price for orders over 6 pcs. Prix pour c.des supérieures à 6 pcs. Precio para mas de 6 pzs Preis für Aufträge von über 6 Stück	Prezzo per ordini superiori a 6 pz. Price for orders over 6 pcs. Prix pour c.des supérieures à 6 pcs. Precio para mas de 6 pzs Preis für Aufträge von über 6 Stück	Prezzo per ordini superiori a 6 pz. Price for orders over 6 pcs. Prix pour c.des supérieures à 6 pcs. Precio para mas de 6 pzs Preis für Aufträge von über 6 Stück	Prezzo per ordini superiori a 6 pz. Price for orders over 6 pcs. Prix pour c.des supérieures à 6 pcs. Precio para mas de 6 pzs Preis für Aufträge von über 6 Stück	Prezzo per ordini superiori a 6 pz. Price for orders over 6 pcs. Prix pour c.des supérieures à 6 pcs. Precio para mas de 6 pzs Preis für Aufträge von über 6 Stück	Prezzo per ordini superiori a 6 pz. Price for orders over 6 pcs. Prix pour c.des supérieures à 6 pcs. Precio para mas de 6 pzs Preis für Aufträge von über 6 Stück	
CL.	BO	GR	T	BO	GR	T	
DS.	Passacavi composto da 12 elementi completo di attacco a scrivania e peso Cables holder with 12 elements, desk fixing bracket and terminal ballast included Canalisation avec 12 éléments.Etrier de fixation au bureau et ballast inclus Pasacables con 12 elementos, abrazadera de enganche y peso terminal incluidos Kabelhalter, besteht aus 12 Elementen. Komplet mit Schreibtischanschlussstück und Gewicht			50 elementi passacavo lunghezza totale 298 cm 50 elements for cables holder total length 298 cm 50 elements pour canalisation longueur totale 298 cm 50 elementos pasacables longitud total 298 cm 50 Kabelhalterelemente, Länge total 298 cm			
							
CD.	1744-BO	1744-GR	1744-T	1745-N	1746-N		
PR.	CHF 27 (5 pcs.)	CHF 27 (5 pcs.)	CHF 28 (5 pcs.)	CHF 52 (5 pcs.)	CHF 16		
CL.	BO	GR	T	N	N		
DS.	Confezione 5 attacchi per passacavi 5 fixing brackets for cables holder 5 étriers de fixation pour canalisation 5 abrazaderas de enganche para pasacables 5 Befestigungen für Kabelhalter			Confezione 5 pesi per passacavi 5 ballast for cables holder 5 ballast pour canalisation 5 pesos terminales para pasacables 5 Gewichte für Kabelhalter			Raccordo per passacavi Connection element for cable holder Élément raccordant pour canalisation Elemento de unión para pasacables Verbindungstück für Kabelhalter

CD.	1658-EN	1656-EN	1657-EN	1659-EN
PR.	CHF 195	CHF 183	CHF 83	CHF 247
CL.	N	N	N	N
DS.	Pelle rigenerata Regenerated leather Cuir régénéré Cuero regenerado Regeneriertes Leder			

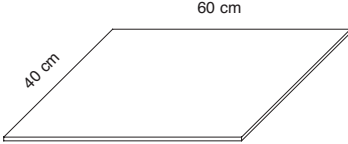
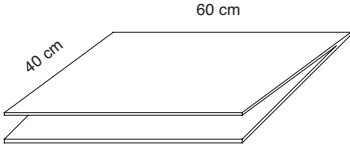
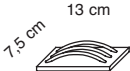
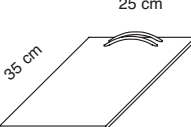
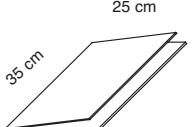
FORME/MASTER

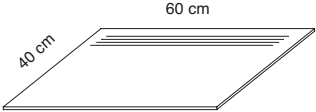
CD.	1628	1628-CU	1626	1626-CU	1627	1627-CU	1623	1623-CU
PR.	CHF 181	CHF 181	CHF 145	CHF 145	CHF 102	CHF 102	CHF 82	CHF 82
CL.	N	CU	N	CU	N	CU	N	CU
DS.	Pelle ecologica Ecological leather Cuir écologique Piel ecologica Lederimitation							
CD.	1610	1610-CU	1611	1611-CU				
PR.	CHF 796	CHF 796	CHF 714	CHF 714				
CL.	N	CU	N	CU				
DS.	Pelle ecologica Ecological leather Cuir écologique Piel ecologica Lederimitation							

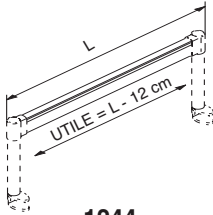
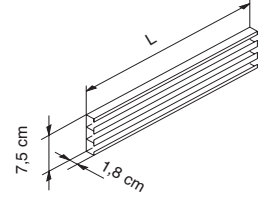
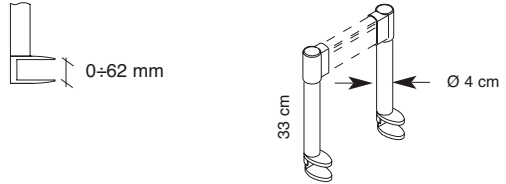
					
CD.	1629		1629-CU		1630
PR.	CHF 179		CHF 179		CHF 273
CL.	N		CU		N
DS.	Pelle ecologica Ecological leather Cuir écologique Piel ecologica Lederimitation				
					
CD.	1633		1632		1631
PR.	CHF 136		CHF 160		CHF 160
CL.	N		N		N
DS.	Pelle ecologica Ecological leather Cuir écologique Piel ecologica Lederimitation				
	2 pz.per scatola - Box of 2 pcs - Conditionnement à 2 pcs - 2 pz.por embalaje - 2 Stücke Verpackung 	2 pz.per scatola - Box of 2 pcs - Conditionnement à 2 pcs - 2 pz.por embalaje - 2 Stücke Verpackung 	TOP	TOP	TOP
CD.	1463	1463-M	1639	1637	1635
PR.	CHF 89 / 2 St.	CHF 136 / 2 St.	CHF 191	CHF 104	CHF 122
CL.	N	N	N	N	N
DS.	Sottomano in espanso nero Desk pad in black polyurethane foam Sous-mail en polyuréthane noir Carpeta de expandido negro Schreibunterlage aus schwarzem Schaumstoff		Sottomano in poliuretano espanso nero Desk pad in black polyurethane foam Sous-mail en polyuréthane noir Carpeta de espuma de poliuretano negro Schreibunterlage aus schwarzem Polyurethanschaum		

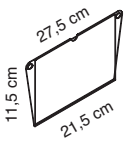
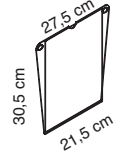
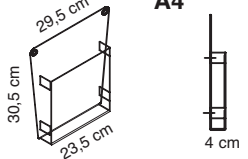
	 <p>1240 = L 79,5 cm 1242 = L 119,5 cm # 1244 = L 139,5 cm 1246 = L 159,5 cm 1248 = L 179,5 cm #</p>					 <p>1271 = L 97 cm # 1272 = L 117 cm # 1276 = L 157 cm #</p>		
CD.	1240	1242	1244	1246	1248	1271	1272	1276
PR.	CHF 103	#	CHF 128	CHF 134	#	#	CHF 119	#
CL.	AL	AL	AL	AL	AL	AL	AL	AL
DS.	<p>Profili in alluminio anodizzato per montaggio su colonne Anodized aluminium profiles to be fixed on columns Profils en aluminium anodisé à fixer sur les colonnes Perfiles en aluminio anodizado para el montaje de columnas Profile aus eloxiertem Aluminium für Montage auf Tragsäulen</p>					<p>Profili in alluminio anodizzato per montaggio su parete - completo di 2 tappi terminali neri Anodized aluminium profiles for wall fixing - 2 black caps included Profils en aluminium anodisé pour fixation au mur - avec 2 taquets noirs Perfiles en aluminio anodizado para el montaje á pared - 2 tapas negras incluidas Profile aus eloxiertem Aluminium für Wandmontage - 2 Abdeckkappen inklusive</p>		
CD.	 <p>1232</p>					 <p>1296</p>		
PR.	CHF 139 (2 pcs.)					CHF 5		
CL.	GM					N - GM		
DS.	<p>Colonne in acciaio verniciato, tecnopolimero e zama da utilizzare con i profili in alluminio Powder-coated steel, zama and polymer columns to be used with aluminium profiles Colonnes en acier époxy, polymère et zama à utiliser avec les profils en aluminium Columnas en acero barnizado, tecnopolimero, zama á utilizar con los perfiles de aluminio Tragsäulen aus beschichtetem Stahl, Kunststoff und Zama-Legierung mit den Aluminiumprofilen zu benutzen</p>					<p>Adapter in tecnopolimero per lampade Polymer adapter for lamps Adaptateur en polymère pour lampes Adaptator en tecnopolimero para lámparas Adapter aus Kunststoff für Lampe</p>		
CD.	 <p>21,5 x 11</p> <p>1235-T</p>		 <p>A4</p> <p>1237-T</p>		 <p>A4</p> <p>1239-T</p>			
PR.	CHF 52		CHF 62		CHF 122			
CL.	T		T		T			
DS.	<p>Espositore in metacrilato trasparente Transparent methacrylate display unit Presentoir en méthacrylate transparent Expositor en metacrilato transparente Präsentationsschild aus transparentem Methacrylat</p>		<p>Espositore in metacrilato trasparente Transparent methacrylate display unit Presentoir en méthacrylate transparent Expositor en metacrilato transparente Präsentationsschild aus transparentem Methacrylat</p>		<p>Portadépliant in metacrilato trasparente Leaflet holder methacrylate display unit Porte-dépliants en méthacrylate transparent Soporte para folletos en metacrilato transparente Prospekte Behälter aus transparentem Methacrylat</p>			
<p>(#) Disponibili solo per quantitativi, prezzi su richiesta - (#) Available in large numbers only, prices on request - (#) Disponibles seulement pour quantités, prix sur demande - (#) Disponibles solo por cantidades, solicitar precio - (#) Erhältlich nur bei umfangreichen Bestellungen, Preis auf Anfrage</p>								

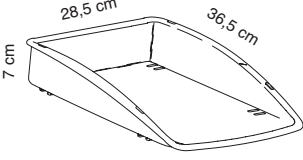
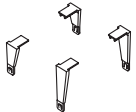
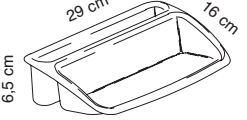
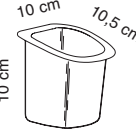
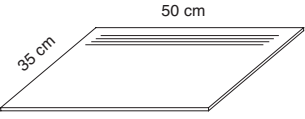
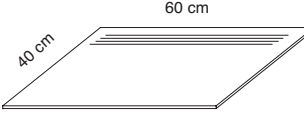
	<p>2 pz.per scatola - Box of 2 pcs Conditionnement à 2 pcs 2 pz.por embalaje - 2 Stücke Verpackung</p> 							
CD.	1330-T	1330-GM	1330-B	1330-N	1331-T	1331-GM	1331-B	1331-N
PR.	CHF 77 / 2 St.	CHF 121 / 2 St.	CHF 77 / 2 St.	CHF 77 / 2 St.	CHF 15 (4 pcs.)	CHF 21 (4 pcs.)	CHF 15 (4 pcs.)	CHF 15 (4 pcs.)
CL.	T - TRO	GM	B	N	T - TRO	GM	B	N
DS.	<p>Portacorrispondenza in policarbonato trasparente, rosso trasparente, bianco, nero o grigio metallizzato Transparent, red transparent, white, black or metal grey polycarbonate letter tray Bac à courrier en polycarbonate transparent, rouge transparent, blanc, noir ou gris métallisé Portacorrespondencia en policarbonado transparente, rojo transparente, blanco, negro o gris metalizado Ablagekorb aus farblosem, rot transparentem, weissem, schwarzem oder alufarbigem Polykarbonat</p>				<p>Supporti in policarbonato trasparente, rosso trasparente, bianco, nero o grigio metallizzato Transparent, red transparent, white, black or metal grey polycarbonate supports Supports polycarbonate transparent, rouge transparent, blanc, noir ou gris métallisé Soportes en policarbonado transparente, rojo transparente, blanco, negro o gris metalizado Stützen aus farblosem, rot transparentem, weissem, schwarzem oder alufarbigem Polykarbonat</p>			
								
CD.	1336-T	1336-GM	1336-B	1336-N	1338-T	1338-GM	1338-B	1338-N
PR.	CHF 53	CHF 64	CHF 53	CHF 53	CHF 26	CHF 33	CHF 26	CHF 26
CL.	T - TRO	GM	B	N	T - TRO	GM	B	N
DS.	<p>Portaoggetti in policarbonato trasparente, rosso trasparente, bianco, nero o grigio metallizzato Transparent, red transparent, white, black or metal grey polycarbonate pen and clip tray Porte-objets en polycarbonate transparent, rouge transparent, blanc, noir ou gris métallisé Portaobjectos en policarbonado transparente, rojo transparente, blanco, negro o gris metalizado Schreibzeugablage aus farblosem, rot transparentem, weissem, schwarzem oder alufarbigem Polykarbonat</p>				<p>Portamatite in policarbonato trasparente, rosso trasparente, bianco, nero o grigio metallizzato Transparent, red transparent, white, black or metal grey polycarbonate pencil jar. Pot à crayons en polycarbonate transparent, rouge transparent, blanc, noir ou gris métallisé Portalapiceros en policarbonado transparente, rojo transparente, blanco, negro o gris metalizado Bleistiftköcher aus farblosem, rot transparentem, weissem, schwarzem oder alufarbigem Polykarbonat</p>			
	<p>2 pz.per scatola - Box of 2 pcs - Conditionnement à 2 pcs - 2 pz.por embalaje - 2 Stücke Verpackung</p> 				<p>2 pz.per scatola - Box of 2 pcs - Conditionnement à 2 pcs - 2 pz.por embalaje - 2 Stücke Verpackung</p> 			
CD.	1463				1463-M			
PR.	CHF 89 / 2 St.				CHF 136 / 2 St.			
CL.	N				N			
DS.	<p>Sottomano in espanso nero Desk pad in black polyurethane foam Sous-mail en polyuréthane noir Carpeta de expandido negro Schreibunterlage aus schwarzem Schaumstoff</p>							

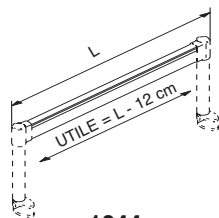

1240 = L 79,5 cm
 1242 = L 119,5 cm #
 1244 = L 139,5 cm
 1246 = L 159,5 cm
 1248 = L 179,5 cm #

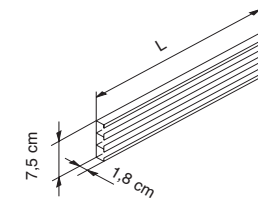

1271 = L 97 cm #
 1272 = L 117 cm
 1276 = L 157 cm #

CD.	1240	1242	1244	1246	1248	1271	1272	1276
PR.	CHF 103	#	CHF 128	CHF 134	#	#	CHF 119	#
CL.	AL	AL	AL	AL	AL	AL	AL	AL

DS.	Profili in alluminio anodizzato per montaggio su colonne Anodized aluminium profiles to be fixed on columns Profiles en aluminium anodisé à fixer sur les colonnes Perfiles en aluminio anodizado para el montaje de columnas Profile aus eloxiertem Aluminium für Montage auf Tragsäulen					Profili in alluminio anodizzato per montaggio su parete - completo di 2 tappi terminali neri Anodized aluminium profiles for wall fixing - 2 black caps included Profiles en aluminium anodisé pour fixation au mur - avec 2 taquets noirs Perfiles en aluminio anodizado para el montaje á pared - 2 tapas negras incluidas Profile aus eloxiertem Aluminium für Wandmontage - 2 Abdeckkappen inklusive		
-----	-------------------------------------------------------------------------------------------------------------------------------------------------------------------------------------------------------------------------------------------------------------------------------------------------------	--	--	--	--	----------------------------------------------------------------------------------------------------------------------------------------------------------------------------------------------------------------------------------------------------------------------------------------------------------------------------------------------------------------------------------------------------------------------	--	--

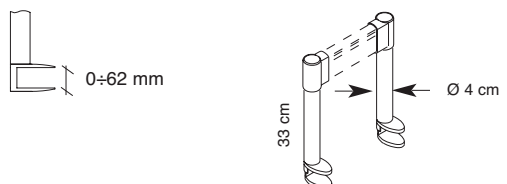

CD.	1232	1296
PR.	CHF 139 (2 pcs.)	CHF 5
CL.	GM	N - GM

DS.	Colonne in acciaio verniciato, tecnopolimero e zama da utilizzare con i profili in alluminio Powder-coated steel, zama and polymer columns to be used with aluminium profiles Colonnes en acier époxy, polymère et zama à utiliser avec les profils en aluminium Columnas en acero barnizado, tecnopolimero, zama á utilizar con los perfiles de aluminio Tragsäulen aus beschichtetem Stahl, Kunststoff und Zama-Legierung mit den Aluminiumprofilen zu benutzen	Adapter in tecnopolimero per lampade Polymer adapter for lamps Adaptateur en polymère pour lampes Adaptator en tecnopolimero para lámparas Adapter aus Kunststoff für Lampe
-----	-------------------------------------------------------------------------------------------------------------------------------------------------------------------------------------------------------------------------------------------------------------------------------------------------------------------------------------------------------------------------------------------------------------------------------------------------------------------------------	-----------------------------------------------------------------------------------------------------------------------------------------------------------------------------------------

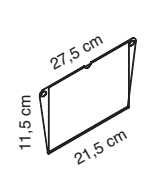

21,5 x 11

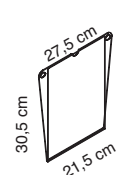

A4

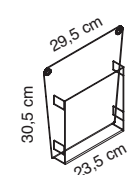



A4



CD.	1235-T	1237-T	1239-T
PR.	CHF 52	CHF 62	CHF 122
CL.	T	T	T

DS.	Espositore in metacrilato trasparente Transparent methacrylate display unit Présentoir en méthacrylate transparent Expositor en metacrilato transparente Präsentationsschild aus transparentem Methacrylat	Espositore in metacrilato trasparente Transparent methacrylate display unit Présentoir en méthacrylate transparent Expositor en metacrilato transparente Präsentationsschild aus transparentem Methacrylat	Portadépliant in metacrilato trasparente Leaflet holder methacrylate display unit Porte-dépliants en méthacrylate transparent Soporte para folletos en metacrilato transparente Prospekte Behälter aus transparentem Methacrylat
-----	------------------------------------------------------------------------------------------------------------------------------------------------------------------------------------------------------------------------	------------------------------------------------------------------------------------------------------------------------------------------------------------------------------------------------------------------------	----------------------------------------------------------------------------------------------------------------------------------------------------------------------------------------------------------------------------------------------

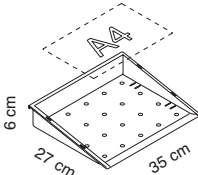
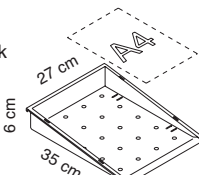
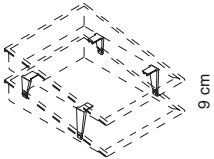
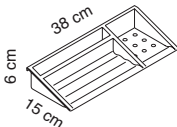
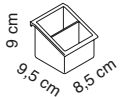
(#) Disponibili solo per quantitativi, prezzi su richiesta - (#) Available in large numbers only, prices on request - (#) Disponibles seulement pour quantités, prix sur demande - (#) Disponibles solo por cantidades, solicitar precio - (#) Erhältlich nur bei umfangreichen Bestellungen, Preis auf Anfrage

	<p>2 pz.per scatola - Box of 2 pcs Conditionnement à 2 pcs 2 pz.por embalaje - Verpackungseinheit 2 Stück</p> 					<p>2 pz.per scatola - Box of 2 pcs Conditionnement à 2 pcs 2 pz.por embalaje - Verpackungseinheit 2 Stück</p> 				
CD.	1209	1209-BO	1209-T	1209-TB	1209-GM	1200	1200-BO	1200-T	1200-TB	1200-GM
PR.	CHF 57 / 2 St.	CHF 64 / 2 St.	CHF 68 / 2 St.	CHF 68 / 2 St.	CHF 112 / 2 St.	CHF 57 / 2 St.	CHF 64 / 2 St.	CHF 68 / 2 St.	CHF 68 / 2 St.	CHF 112 / 2 St.
CL.	N	BO	T	TB	GM	N	BO	T	TB	GM
DS.	<p>Portacorrispondenza in tecnopolimero nero o grigio metallizzato o bianco opaco oppure in policarbonato trasparente o blu trasparente Black or metal grey or mat white polymer or transparent or blue transparent polycarbonate letter tray Bac à courrier en polymère noir ou gris métallisé ou blanc mat ou polycarbonate transparent ou bleu transparent Porta corrispondencia en tecnopolimero negro o gris o blanco mate metalizado o policarbonado trasparente o azul transparente Ablagekörbe aus schwarzem, alufarbigem oder mattweissem Kunststoff, oder aus transparentem oder blau transparentem Polykarbonat</p>									
										
CD.	1201	1201-BO	1201-T	1201-TB	1201-GM	1206	1206-BO	1206-T	1206-TB	1206-GM
PR.	CHF 11 (4 pcs.)	CHF 12 (4 pcs.)	CHF 13 (4 pcs.)	CHF 13 (4 pcs.)	CHF 20 (4 pcs.)	CHF 41	CHF 42	CHF 49	CHF 49	CHF 62
CL.	N	BO	T	TB	GM	N	BO	T	TB	GM
DS.	<p>Supporti in tecnopolimero nero o grigio metallizzato o bianco opaco oppure in policarbonato trasparente o blu trasparente Black or metal grey polymer or transparent or blue transparent polycarbonate supports Supports en polymère noir ou gris métallisé ou blanc mat ou polycarbonate transparent ou bleu transparent Soportes en tecnopolimero negro o gris o blanco mate metalizado o policarbonado transparente o azul transparente Halter aus schwarzem, alufarbigem oder mattweissem Kunststoff, oder aus transparentem oder blau transparentem Polykarbonat</p>					<p>Portaoggetti in tecnopolimero nero o grigio metallizzato o bianco opaco oppure in policarbonato trasparente o blu trasparente Black or metal grey polymer or transparent or blue transparent polycarbonate object holder Porte-objet en polymère noir ou gris métallisé ou blanc mat ou polycarbonate transparent ou bleu transparent Portaobjeto en tecnopolimero negro o gris o blanco mate metalizado o policarbonado transparente o azul transparente Objekträger aus schwarzem, alufarbigem oder mattweissem Kunststoff, oder aus transparentem oder blau transparentem Polykarbonat</p>				
										
CD.	1208	1208-BO	1208-T	1208-TB	1208-GM					1204-T
PR.	CHF 20	CHF 21	CHF 25	CHF 25	CHF 31					CHF 31
CL.	N	BO	T	TB	GM					T
DS.	<p>Portamatite in tecnopolimero nero o grigio metallizzato o bianco opaco oppure in policarbonato trasparente o blu trasparente Black or metal grey polymer or transparent or blue transparent polycarbonate pen holder Pot à crayons en polymère noir ou gris métallisé ou blanc mat ou polycarbonate transparent ou bleu transparent Portalapiceros en tecnopolimero negro o gris o blanco mate metalizado o policarbonado transparente o azul transparente Bleistiftköcher aus schwarzem, alufarbigem oder mattweissem Kunststoff, oder aus transparentem oder blau transparentem Polykarbonat</p>					<p>Porta CD-floppy disk in policarbonato trasparente Transparent polycarbonate CD-floppy holder Porte CD et disquettes en polycarbonate transparent Archivador de CD y discos en policarbonado transparente CD- und Diskettenhalterung aus transparentem Polykarbonat</p>				

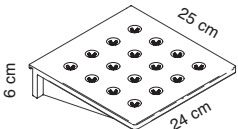
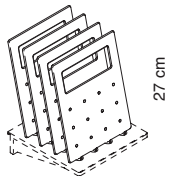
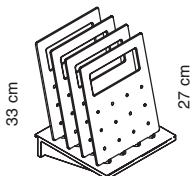
			
CD.	1212-T	1213-T	1214-T
PR.	CHF 38	CHF 38 (4 pcs.)	CHF 76
CL.	T	T	T
DS.	Ripiano in policarbonato trasparente Transparent polycarbonate shelf Tablette en polycarbonate transparent Estante en policarbonato transparente Ablageboden aus transparentem Polykarbonat	4 separatori in policarbonato trasparente 4 transparent polycarbonate separators 4 séparateurs en polycarbonate transparent 4 separadores en policarbonato transparente 4 Trenner aus transparentem Polykarbonat	Ripiano completo di 4 separatori in policarbonato trasparente Shelf with 4 separators in transparent polycarbonate Tablette avec 4 séparateurs en polycarbonate transparent Estante con 4 separadores en policarbonato transparente Ablageboden mit 4 Trennern aus transparentem Polykarbonat

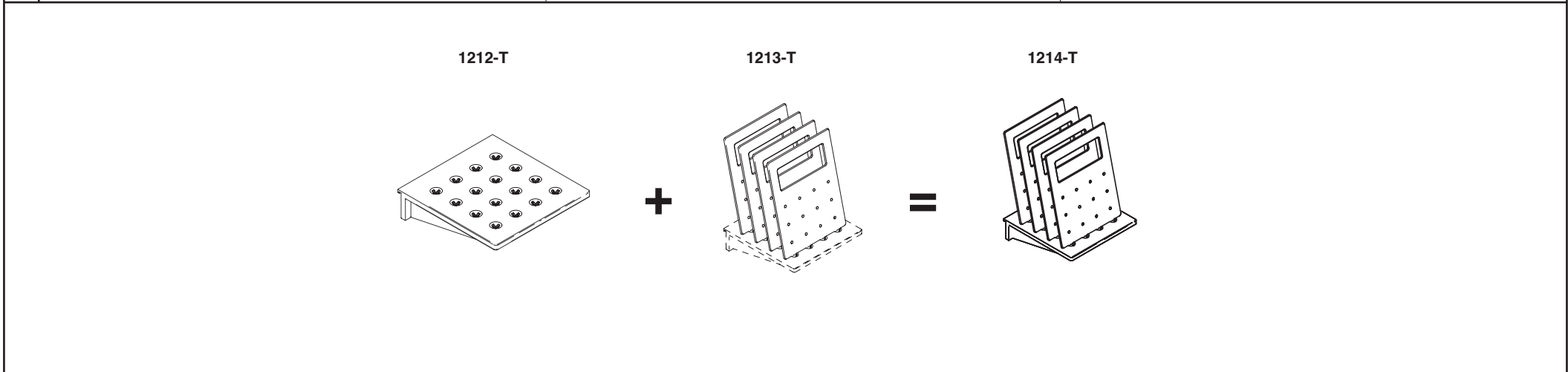

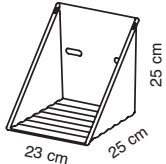
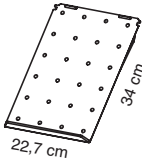
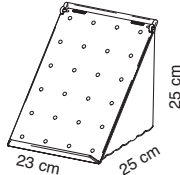
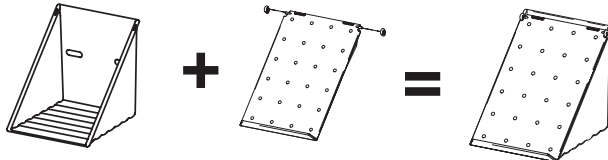
CD.	<p>2 pz.per scatola - Box of 2 pcs. - Conditionnement à 2 pcs 2 pz.por embalaje - Verpackungseinheit 2 Stück</p>  <p>1202-T</p>	<p>2 pz.per scatola - Box of 2 pcs. - Conditionnement à 2 pcs 2 pz.por embalaje - Verpackungseinheit 2 Stück</p>  <p>1203-T</p>	<p>2 pz.per scatola - Box of 2 pcs. - Conditionnement à 2 pcs 2 pz.por embalaje - Verpackungseinheit 2 Stück</p>  <p>1211-T</p>
PR.	CHF 135 / 2 St.	CHF 73 / 2 St.	CHF 208 / 2 St.
CL.	T	T	T
DS.	<p>Porta folder in policarbonato trasparente Transparent polycarbonate file holder Bac à classeur en polycarbonate transparent Archivador en policarbonado transparente Ordnerständer aus transparentem Polykarbonat</p>	<p>Leggio in policarbonato trasparente Transparent polycarbonate copy holder Pupitre en polycarbonate transparent Copiadora en policarbonado transparente Vorlagenhalter aus transparentem Polykarbonat</p>	<p>Porta folder con leggio in policarbonato trasparente Transparent polycarbonate file holder with copy holder Bac à classeur avec pupitre en polycarbonate transparent Archivador con copiadora en policarbonado transparente Ordnerständer mit Vorlagenhalter aus transparentem Polykarbonat</p>
<p>1202-T 1203-T 1211-T</p> 			
CD.	<p>1205</p>	<p>1205-T</p>	<p>1205-TB</p>
PR.	CHF 22	CHF 26	CHF 26
CL.	N	T	TB
DS.	<p>Porta fiori in tecnopolimero nero oppure in policarbonato trasparente o blu trasparente Black polymer or transparent or blue transparent polycarbonate flower pot Porte-fleurs en polymère noir ou polycarbonate transparent ou bleu transparent Florero en tecnopolimero negro o policarbonado transparente o azul transparente Blumenvase aus schwarzem Kunststoff oder transparentem oder blau transparentem Polykarbonat</p>		

ø 4,5 cm



13 cm