

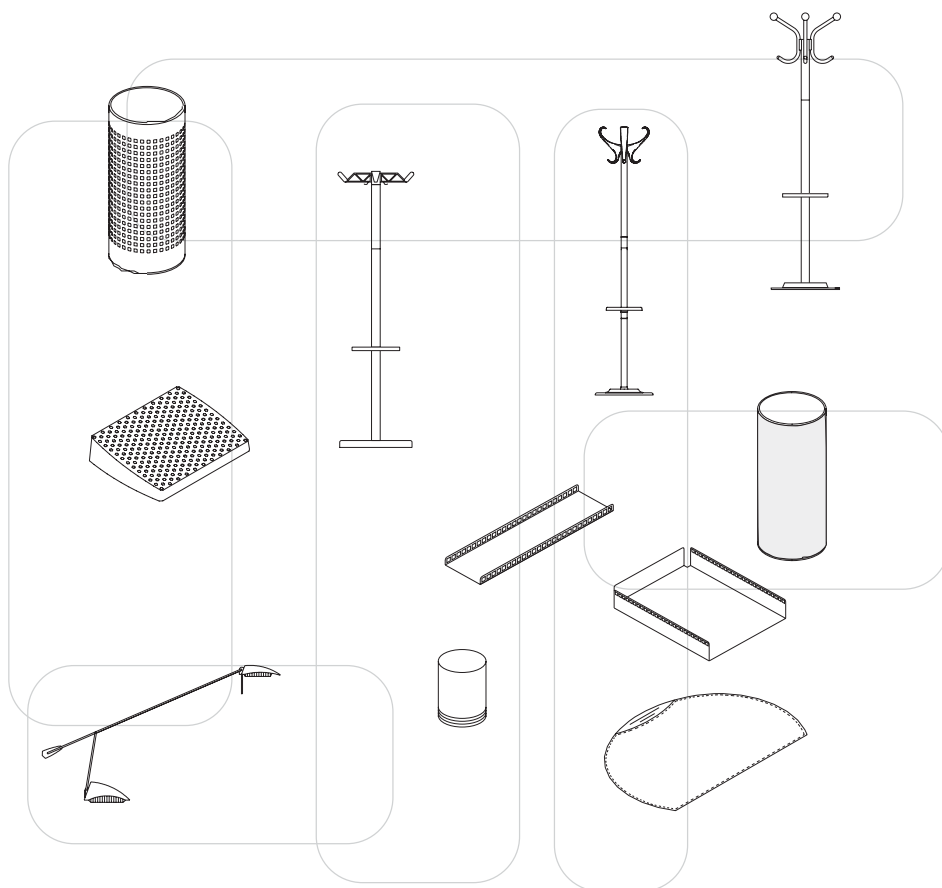





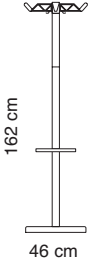
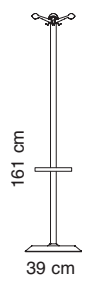
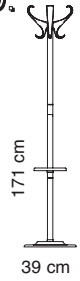
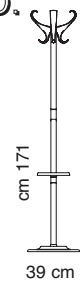
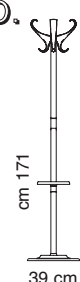

Creando

ACCESSORI & LUCI



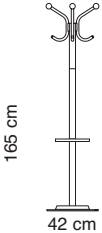
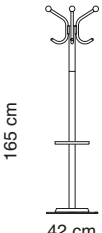
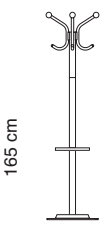
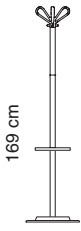
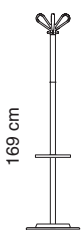
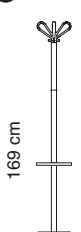

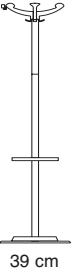
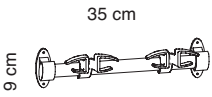
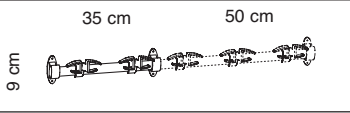
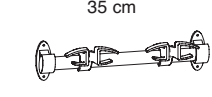
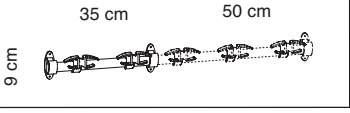
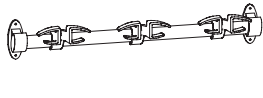
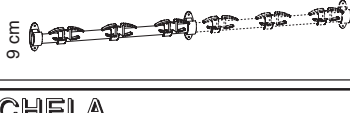
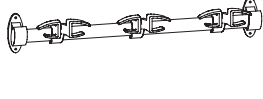
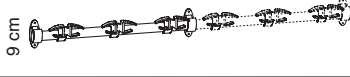

	ACCESSORI			PREZZO PRICE PRIX
	ARTICOLO ITEM ARTICLE	COLORI COLOURS COULEURS	DESCRIZIONE DESCRIPTION DESCRIPTION	
EIFFEL  <p>162 cm 46 cm</p>	80214-N	N	Portabiti con portaombrelli. <i>Coat stand with umbrella ring and drip tray</i> Portemanteau avec porte-parapluies. <i>Kleiderständer mit Schirmring</i>	CHF 105
	80214-GM	GM	Perchero con paragüero.	
	80214/6-N	N	N. 6 portabiti con portaombrelli. <i>6 coat stands with umbrella ring and drip tray</i> 6 portemanteaux avec porte-parapluies. <i>6 Kleiderständer mit Schirmring</i>	CHF 576 (6 pz.) (CHF 96 cad.) (Prezzo speciale per 6 pz. imballati singolarmente) (Special price for 6 pcs. individually packaged) (Prix spécial pour 6 pièces emballés individuellement) (Sonderpreis für 6 Stücke einzeln verpackt) (Precio especial para 6 pzs empaquetados individualmente)
	80214/6-GM	GM	6 percheros con paragüero.	
HILL  <p>161 cm 39 cm</p>	80203-N	N	Portabiti con portaombrelli. <i>Coat stand with umbrella ring and drip tray</i> Portemanteau avec porte-parapluies. <i>Kleiderständer mit Schirmring</i>	CHF 119
	80203-GM	GM	Perchero paragüero.	
ARTU' P.O.  <p>171 cm 39 cm</p>	80240-N	N	Portabiti con portaombrelli. Testa nera o grigia <i>Coat stand with umbrella ring and drip tray. Black or grey head.</i>	CHF 152
	80240-GM	GM	Portemanteau avec porte-parapluies. Tête noir ou gris. <i>Kleiderständer mit Schirmring. Schwarz oder grau Kopf</i> Perchero paragüero. Cabeza negra o gris	
ARTU' P.O.  <p>cm 171 39 cm</p>	80240-T	GM	Portabiti con portaombrelli. Testa trasparente. <i>Coat stand with umbrella ring and drip tray. Translucent head.</i>	CHF 177
ARTU' P.O.  <p>cm 171 39 cm</p>	80240-TBO	BO	Portabiti con portaombrelli. Testa trasparente. <i>Coat stand with umbrella ring and drip tray. Translucent head.</i>	CHF 177

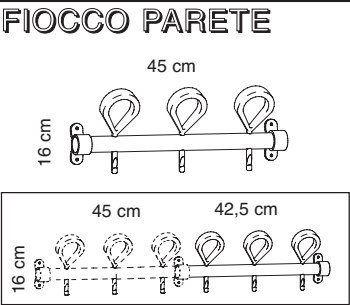
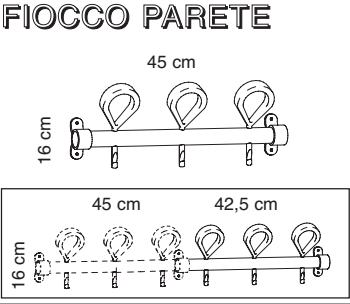
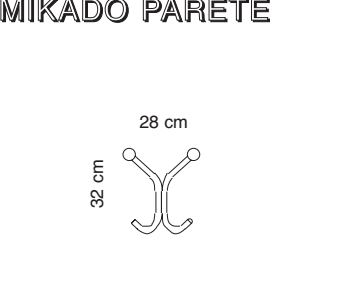
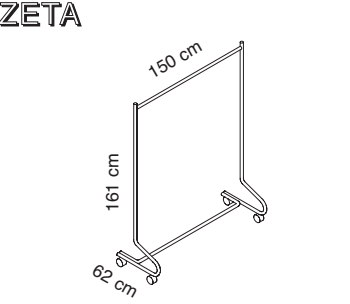
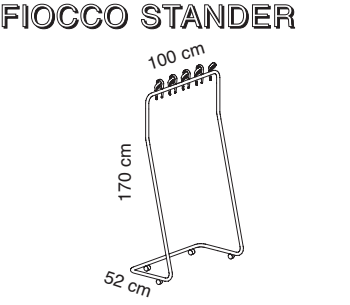
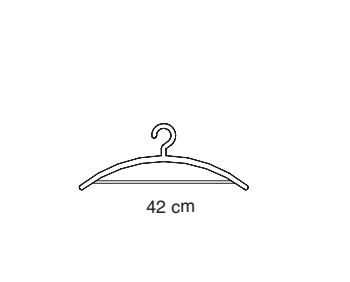
	ACCESSORI			PREZZO PRICE PRIX
	ARTICOLO ITEM ARTICLE	COLORI COLOURS COULEURS	DESCRIZIONE DESCRIPTION DESCRIPTION	
DECO'  165 cm 42 cm	80220	N GM	Portabiti con portaombrelli. <i>Coat stand with umbrella ring and drip tray</i> Portemanteau avec porte-parapluies <i>Kleiderständer mit Schirmring</i> Perchero paragüero	CHF 161
DECO' CROMO  165 cm 42 cm	80220-C	CR	Portabiti cromato con portaombrelli. <i>Chrome-plated coat stand with umbrella ring and drip tray</i> Portemanteau chromé avec porte-parapluies <i>Verchromte Kleiderständer mit Schirmring</i> Perchero paragüero cromado	CHF 192
DECO' LEGNO  165 cm 42 cm	80221	GM	Portabiti con portaombrelli con pomoli in legno. <i>Coat stand with umbrella ring and drip tray. Wooden knob.</i> Portemanteau avec porte-parapluies. Bouton en bois. <i>Kleiderständer mit Schirmring. Holzknöpfe.</i> Perchero paragüero. Pomo en madera.	CHF 198
FIOCCO  169 cm 39 cm	80230-N	N	Portabiti con portaombrelli. Fusto e testa neri <i>Coat stand with umbrella ring and drip tray. Black stem and head</i> Portemanteau avec porte-parapluies. Tube et tête noirs <i>Kleiderständer mit Schirmring. Kopf und gestell schwarz</i> Perchero paragüero. Estructura y cabeza negra	CHF 163
FIOCCO  169 cm 39 cm	80230-T	GM	Portabiti con portaombrelli. Fusto: GM / Testa: Trasparente <i>Coat stand with umbrella ring and drip tray. Stem: GM / Head: translucent</i> Portemanteau avec porte-parapluies Tube: GM / Tête: Transparente <i>Kleiderständer mit Schirmring. Gestell: GM / Kopf: Transparent</i> Perchero paragüero. Estructura: GM / Cabeza: Transparente	CHF 180
FIOCCO  169 cm 39 cm	80230-TB	GM	Portabiti con portaombrelli. Fusto: GM / Testa: Trasparente blu <i>Coat stand with umbrella ring and drip tray. Stem: GM / Head: translucent blue</i> Portemanteau avec porte-parapluies Tube: GM / Tête: Blue transparente <i>Kleiderständer mit Schirmring. Gestell: GM / Kopf: Transparent-blau</i> Perchero paragüero. Estructura: GM / Cabeza: Azul transparente	CHF 180

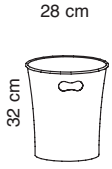
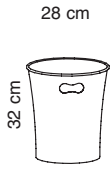
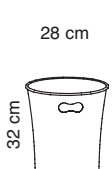
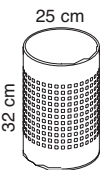
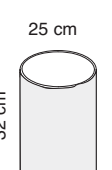

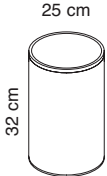
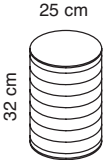

	ACCESSORI			PREZZO PRICE PRIX
	ARTICOLO ITEM ARTICLE	COLORI COLOURS COULEURS	DESCRIZIONE DESCRIPTION DESCRIPTION	
ARCO 	80210-N	N	Portabiti. <i>Coat stand.</i> Portemanteau. <i>Kleiderständer.</i> Perchero.	CHF 179
	80210-GM	GM		
ARCO P.O. 	80211-N	N	Portabiti con portaombrelli. <i>Coat stand with umbrella ring and drip tray</i> Portemanteau avec porte-parapluies <i>Kleiderständer mit Schirmring</i> Perchero paragüero	CHF 192
	80211-GM	GM		
CHELA  	80252-N	N	Portabiti da parete. Collegabili in linea con portabiti Chela a 2 o 3 posti. Wall-fixed coat rail. Can be connected with the coat rail Chela with 2 or 3 hooks. Portemanteau mural. On peut le relier au portemanteau Chela à 2 ou 3 places. Wandgarderobe. Kann mit der Garderobe Chela mit 2 oder 3 Haken verbunden werden. Perchero de pared. Conectable con perchero Chela 2 o 3 ganchos.	CHF 62
CHELA  	80252-T	T	Portabiti da parete. Collegabili in linea con portabiti Chela a 2 o 3 posti. Wall-fixed coat rail. Can be connected with the coat rail Chela with 2 or 3 hooks. Portemanteau mural. On peut le relier au portemanteau Chela à 2 ou 3 places. Wandgarderobe. Kann mit der Garderobe Chela mit 2 oder 3 Haken verbunden werden. Perchero de pared. Conectable con perchero Chela 2 o 3 ganchos.	CHF 86
CHELA  	80253-N	N	Portabiti da parete. Collegabili in linea con portabiti Chela a 2 o 3 posti. Wall-fixed coat rail. Can be connected with the coat rail Chela with 2 or 3 hooks. Portemanteau mural. On peut le relier au portemanteau Chela à 2 ou 3 places. Wandgarderobe. Kann mit der Garderobe Chela mit 2 oder 3 Haken verbunden werden. Perchero de pared. Conectable con perchero Chela 2 o 3 ganchos.	CHF 72
CHELA  	80253-T	T	Portabiti da parete. Collegabili in linea con portabiti Chela a 2 o 3 posti. Wall-fixed coat rail. Can be connected with the coat rail Chela with 2 or 3 hooks. Portemanteau mural. On peut le relier au portemanteau Chela à 2 ou 3 places. Wandgarderobe. Kann mit der Garderobe Chela mit 2 oder 3 Haken verbunden werden. Perchero de pared. Conectable con perchero Chela 2 o 3 ganchos.	CHF 96

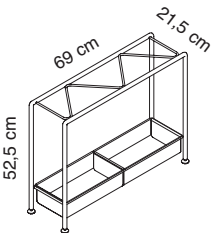
	ACCESSORI			PREZZO PRICE PRIX
	ARTICOLO ITEM ARTICLE	COLORI COLOURS COULEURS	DESCRIZIONE DESCRIPTION DESCRIPTION	
FIOTTO PARETE 	80232-N	N	Portabiti da parete. <i>Wall-fixed coat rail.</i> Portemanteau mural <i>Wandgarderobe.</i> Perchero a pared.	CHF 88
FIOTTO PARETE 	80232-TB	TB	Portabiti da parete. <i>Wall-fixed coat rail.</i> Portemanteau mural <i>Wandgarderobe.</i> Perchero a pared.	CHF 119
MIKADO PARETE 	80225	GM	Portabiti da parete. <i>Wall-fixed hook</i> Portemanteau mural. <i>Wandgarderobe.</i> Perchero a pared	CHF 67
ZETA 	80250-GM	GM	Portabiti mobile su ruote. <i>Movable coat rail.</i> Portemanteau sur roulettes. Rollgarderobe. Perchero movil.	CHF 334
FIOTTO STANDER 	80235-N	GM	Portabiti mobile su ruote. Struttura GM, ganci neri <i>Movable coat rail.</i> <i>Metal grey frame and black hooks</i> Portemanteau sur roulettes. Structure gris métall., crochets noirs Rollgarderobe. <i>Graue metallic Struktur, schwarze Haken</i> Perchero movil. Estructura gris metalizado, ganchos negros	CHF 473
	81530/4-GR	GR	Gruccia portabiti in polipropilene. <i>Polypropylene hanger</i> Cintre en polypropylène <i>Kleiderbügel aus Polypropilten</i> Perchas en polipropileno (Confezione da 4 pezzi - <i>Set of 4 pcs</i> - Set 4 pièces - Set mit 4 Stücke - Set 4 pzs)	CHF 43 (Prezzo per 4 pz) (Price for 4 pcs) (Prix pour 4 pcs) (Preis für 4 Stücke) (Precio para 4 pzs)

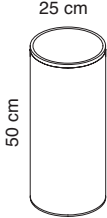
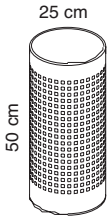
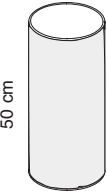
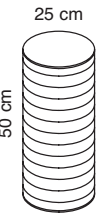
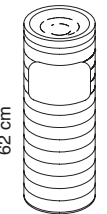
	ACCESSORI			PREZZO PRICE PRIX
	ARTICOLO ITEM ARTICLE	COLORI COLOURS COULEURS	DESCRIZIONE DESCRIPTION DESCRIPTION	
OTTO 	80315-N	N	Cestino gettacarta in polipropilene. <i>Polypropylene wastepaper bin.</i> Corbeille à papier en polypropylène <i>Papierkorb aus Polypropylen.</i> Papelera en polipropileno.	CHF 29
	80315-GR	GR		
	80315/10-N	N	N. 10 cestini gettacarta in polipropilene. <i>10 polypropylene wastepaper bins.</i> 10 corbeilles à papier en polypropylène <i>10 Papierkorb aus Polypropylen.</i> 10 papelera en polipropileno.	CHF 240 (10 pz.) (CHF 24 cad.) (Prezzo speciale per 10 pz.) (Special price for 10 pcs.) (Prix spécial pour 10 pièces) (Sonderpreis für 10 Stücke) (Precio especial para 10 pzs)
	80315/10-GR	GR		
OTTO 	80315-BO	BO	Cestino gettacarta in polipropilene. <i>Polypropylene wastepaper bin.</i> Corbeille à papier en polypropylène <i>Papierkorb aus Polypropylen.</i> Papelera en polipropileno.	CHF 29
OTTO 	80315-TB	TB	Cestino gettacarta in polipropilene traslucido blu. <i>Translucent blue polypropylene wastepaper bin.</i> Corbeille à papier en polypropylène bleu translucide. <i>Papierkorb aus transparent-blauem Polypropylen.</i> Papelera en polipropileno azul transparente.	CHF 36
	80315-TA	TA		
QUADRA 	80320	N	Fusto nero, anello e base neri. Fusto grigio metallizzato, anello e base grigio. <i>Black drum. Black ring and base.</i> <i>Metal grey drum. Grey ring and base.</i> Fût noir, anneau et base noirs. Fût gris métallisé, anneau et base gris.	CHF 67
	80320-GM	GM	<i>Schwarze Gehäuse, schwarze Basis.</i> <i>Grau metallic Gehäuse, grau Basis.</i> Cuerpo negro, anillo y base negra. Cuerpo gris metal, anillo y base gris.	
QUADRA INOX 	80320-I	I	Cestino gettacarta in acciaio inox. <i>Stainless steel wastepaper bin.</i> Corbeille à papier en acier inox <i>Papierkorb aus Edelstahl.</i> Papelera en acero inox.	CHF 119

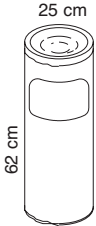
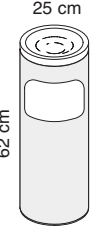
	ACCESSORI			PREZZO PRICE PRIX
	ARTICOLO ITEM ARTICLE	COLORI COLOURS COULEURS	DESCRIZIONE DESCRIPTION DESCRIPTION	
QUADRA 	80324-N	N	Cestino gettacarte in acciaio verniciato con polveri epossidiche. <i>Epoxy painted steel wastepaper bin.</i> Corbeille a papier en acier peint en époxy. <i>Papierkorb aus mit Epoxypulvern beschichtetem Stahl.</i>	CHF 52
	80324-GM	GM	Papelera en acero pintado con polvos epoxídicos.	
	80324/10-N	N	N. 10 cestini gettacarte in acciaio verniciato con polveri epossidiche. <i>10 epoxy painted steel wastepaper bins.</i> 10 corbeilles a papier en acier peint en époxy. <i>10 Papierkorb aus mit Epoxypulvern beschichtetem Stahl.</i>	CHF 480 (10 pz.) (CHF. 48 cad.) (Prezzo speciale per 10 pz. imballati singolarmente) (Special price for 10 pcs. individually packaged) (Prix spécial pour 10 pièces emballés individuellement) (Sonderpreis für 10 Stücke einzeln verpackt) (Precio especial para 10 pzs empaquetados individualmente)
	80324/10-GM	GM	10 papeleras en acero pintado con polvos epoxídicos.	
RIGO NGL 	80320-NGL	N	Cestino gettacarta ricoperto in espanso rigato. <i>Wastepaper bin covered with ribbed polyurethane</i> Corbeille à papier recouvert en <i>polyuréthane rayé.</i> <i>Papierkorb mit geripptem Schaumstoff verkleidet.</i> Papelera recubierta con material expandido acanalado.	CHF 119
	8418	N	Reggisacchetto per articoli 80320, 80320-GM, 80320-I, 80320-NGL, 80324-N, 80324-GM <i>Trash bag holder for 80320, 80320-GM, 80320-I, 80320-NGL, 80324-N, 80324-GM</i>	CHF 16
	8418-GR	GR	Porte-sacs pour les articles 80320, 80320-GM, 80320-I, 80320-NGL, 80324-N, 80324-GM <i>Haltering für Müllbeutel für Art 80320, 80320-GM, 80320-I, 80320-NGL, 80324-N, 80324-GM</i> Sujeta bolsas para ref. 80320, 80320-GM, 80320-I, 80320-NGL, 80324-N, 80324-GM	
	8419	N	Reggisacchetto per articoli 80320, 80320-GM, 80320-I, 80320-NGL <i>Trash bag holder for 80320, 80320-GM, 80320-I, 80320-NGL, 80324-N, 80324-GM</i> Porte-sacs pour les articles 80320, 80320-GM, 80320-I, 80320-NGL <i>Haltering für Müllbeutel für Art. 80320, 80320-GM, 80320-I, 80320-NGL, 80324-N, 80324-GM</i> Sujeta bolsas para ref. 80320, 80320-GM, 80320-I, 80320-NGL, 80324-N, 80324-GM	CHF 16
RAIN 	80318-GM	GM	Portaombrelli. <i>Umbrella stand</i> Porte-parapluies <i>Schirmständer</i> Paragüero	CHF 296

	ACCESSORI			PREZZO PRICE PRIX
	ARTICOLO ITEM ARTICLE	COLORI COLOURS COULEURS	DESCRIZIONE DESCRIPTION DESCRIPTION	
QUADRA 	80344-N	N	Portaombrelli in acciaio verniciato con polveri epossidiche. <i>Epoxy painted steel umbrella stand.</i> Porte-parapluies en acier peint en époxy. <i>Schirmständer aus mit Epoxypulvern beschichtetem Stahl.</i>	CHF 79
	80344-GM	GM	Paragüero en acero pintado con polvos epoxidicos.	
	80344/6-N	N	6 portaombrelli in acciaio verniciato con polveri epossidiche. <i>6 epoxy painted steel umbrella stands.</i> 6 porte-parapluies en acier peint en époxy. <i>6 Schirmständer aus mit Epoxypulvern beschichtetem Stahl.</i>	CHF 432 (6 pz.) (CHF 72 cad.) (Prezzo speciale per 6 pz. imballati singolarmente) (Special price for 6 pcs. individually packaged) (Prix spécial pour 6 pièces emballés individuellement) (Sonderpreis für 6 Stücke einzeln verpackt) (Precio especial para 6 pzs empaquetados individualmente)
	80344/6-GM	GM	6 paragüeros en acero pintado con polvos epoxidicos.	
QUADRA 	80340	N	Fusto nero, anello e base neri. Fusto grigio metallizzato, anello e base grigio. <i>Black drum. Black ring and base.</i> <i>Metal grey drum. Grey ring and base.</i>	CHF 107
	80340-GM	GM	Fût noir, anneau et base noirs. Fût gris métalisé, anneau et base gris. <i>Schwarze Gehäuse, schwarze Basis.</i> <i>Grau metallic Gehäuse, grau Basis.</i> Cuerpo negro, anillo y base negra. Cuerpo gris metal, anillo y base gris.	
QUADRA INOX 	80340-I	I	Portaombrelli in acciaio inox. <i>Stainless steel umbrella holder.</i> Porte-parapluies en acier inox <i>Schirmständer aus Edelstahl.</i> Paragüero en acero inox.	CHF 142
RIGO NGL 	80340-NGL	N	Portaombrelli ricoperto in espanso rigato. <i>Umbrella stand covered with ribbed polyurethane.</i> Porte-parapluies recouvert en polyuréthane rayé <i>Schirmständer mit geripptem Schaumstoff verkleidet</i> Paragüero recubierto con material expandido acanalado.	CHF 167
RIGO NGL 	80300-NGL	N	Posacenere da terra con gettacarte ricoperto in espanso rigato dotato di doppio fondo. <i>Stainless steel ash/litter bin with double base covered with ribbed polyurethane.</i> Cendrier/corbeille à papier de sol doté de double fond recouvert en polyuréthane rayé. <i>Standascher mit geripptem Schaumstoff verkleidet mit doppeltem Boden.</i> Papelera cenicero con base doble recubierto con material expandido acanalado.	CHF 239

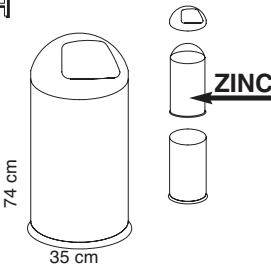
	ACCESSORI			PREZZO PRICE PRIX
	ARTICOLO ITEM ARTICLE	COLORI COLOURS COULEURS	DESCRIZIONE DESCRIPTION DESCRIPTION	
QUADRA 	80300	N GM	Posacenere da terra con gettacarte antincendio dotato di doppio fondo. <i>Flame-retardant ash/litter bin with double base.</i> Cendrier/corbeille à papier de sol antiincendie doté de double fond <i>Feuerhemmender Standascher mit doppeltem Boden.</i> Papelera cenicero antincendio con base doble	CHF 144
QUADRA INOX 	80300-I	I	Posacenere da terra con gettacarte antincendio in acciaio inox dotato di doppio fondo. <i>Stainless steel flame-retardant ash/litter bin with double base.</i> Cendrier/corbeille à papier de sol antiincendie en acier inox doté de double fond <i>Feuerhemmender Standascher aus Edelstahl mit doppeltem Boden.</i> Papelera cenicero antincendio en acero inox con base doble.	CHF 239
	8472	N	Reggisacchetto per articoli: 80300, 80300-I, 80300-NGL <i>Trash bag inner support for ref: 80300, 80300-I, 80300-NGL</i> Porte-sacs pour les articles: 80300, 80300-I, 80300-NGL <i>Müllbeutelhalter für Modelle: 80300, 80300-I, 80300-NGL</i> Sujeta bolsas para Ref.: 80300, 80300-I, 80300-NGL	CHF 66
	80363-I	I	Posacenere ribaltabile a parete in acciaio inox. <i>Stainless steel tilting wall mounted ash-tray</i> Cendrier mural basculant en acier inoxydable. <i>Kippbarer Wand-Aschenbecher aus Edelstahl.</i> Cenicero basculante mural de acero inoxidable.	CHF 179
PATTUMIERA 	80360-I	I	Pattumiere in acciaio inox con cestello interno estraibile in tecnopolimero. <i>Stainless steel litter bins. High-tech polymer inner drum.</i> Poubelles en acier inox avec seau interne extractible en technopolymère. <i>Abfallkörbe aus Edelstahl mit herausnehmbarem Kübel aus Technopolymer.</i> Papelera de acero inoxidable con cubo interior extraíble de tecnopolimero.	CHF 84
PUSH 	80339-GM	GM	Gettacarte in acciaio verniciato. Particolari in tecnopolimero. Cestello interno in acciaio zincato. <i>Steel litter bin. Details in high-tech polymer. Zinc-plated inner drum.</i> Corbeille à papier en acier peint. Détails en technopolymère. Panier interne en acier galvanisé <i>Papierkorb aus beschichtetem Stahl. Beschlägen aus Technopolymer. Innenkorb aus verzinktem Stahl.</i> Papelera en acero pintado. Detalles en tecnopolimero. Cesto interior de acero zincado.	CHF 305

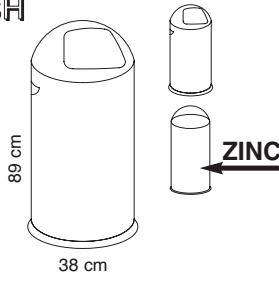
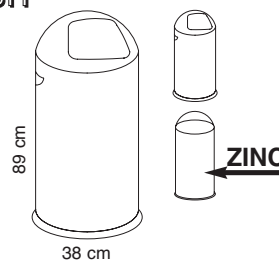
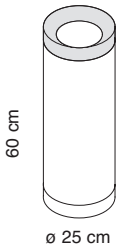
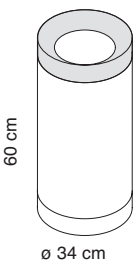
	ACCESSORI			
	ARTICOLO ITEM ARTICLE	COLORI COLOURS COULEURS	DESCRIZIONE DESCRIPTION DESCRIPTION	PREZZO PRICE PRIX
PUSH 	80337-GM	GM	<p>Gettacarte acciaio verniciato. Particolari tecnopolimero. Cestello interno acciaio zincato. <i>Steel litter bin. Details in high-tech polymer. Zinc-plated inner drum.</i></p> <p>Corbeille à papier acier peint. Détails technopolymère. Panier interne acier galvanisé <i>Papierkorb aus beschichtetem Stahl. Beschlägen aus Technopolymer. Innenkorb aus verzinktem Stahl.</i></p> <p>Papelera en acero pintado. Detalles en tecnopolimero. Cesto interior de acero zincado.</p>	CHF 454
PUSH 	80337-I	I	<p>Gettacarte acciaio verniciato. Particolari tecnopolimero. Cestello interno acciaio zincato. <i>Steel litter bin. Details in high-tech polymer. Zinc-plated inner drum.</i></p> <p>Corbeille à papier acier peint. Détails technopolymère. Panier interne acier galvanisé <i>Papierkorb aus beschichtetem Stahl. Beschlägen aus Technopolymer. Innenkorb aus verzinktem Stahl.</i></p> <p>Papelera en acero pintado. Detalles en tecnopolimero. Cesto interior de acero zincado.</p>	CHF 694
RICICLO 	80367-GM	GM	<p>Gettacarte con anello reggisacchetto in acciaio verniciato. <i>Waste bin with liner holder, in painted steel.</i></p> <p>Corbeille à papier avec support sac, en acier peint. <i>Papierkorb mit Müllsackbehälter, aus beschichtetem Stahl.</i></p> <p>Papelera con sujeta bolsas, acero barnizado.</p>	CHF 235
	80367/4-GM	GM	<p>4 gettacarte con anello reggisacchetto in acciaio verniciato. <i>4 waste bins with liner holder, in painted steel.</i></p> <p>4 corbeilles à papier avec support sac, en acier peint. <i>4 Papierkorbe mit Müllsackbehälter, aus beschichtetem Stahl.</i></p> <p>4 papeleras con sujeta bolsas, acero barnizado.</p>	<p>CHF 856 (4 pz.) (CHF. 214 cad.)</p> <p>(Prezzo speciale per 4 pz. imballati singolarmente) (Special price for 4 pcs. individually packaged) (Prix spécial pour 4 pièces emballés individuellement) (Sonderpreis für 4 Stücke einzeln verpackt) (Precio especial para 4 pzs empacquetados individualmente)</p>
RICICLO 	80369-GM	GM	<p>Gettacarte con anello reggisacchetto in acciaio verniciato. <i>Waste bin with liner holder, in painted steel.</i></p> <p>Corbeille à papier avec support sac, en acier peint. <i>Papierkorb mit Müllsackbehälter, aus beschichtetem Stahl.</i></p> <p>Papelera con sujeta bolsas, acero barnizado.</p>	CHF 286
	80369/4-GM	GM	<p>4 gettacarte con anello reggisacchetto in acciaio verniciato. <i>4 waste bins with liner holder, in painted steel.</i></p> <p>4 corbeilles à papier avec support sac, en acier peint. <i>4 Papierkorbe mit Müllsackbehälter, aus beschichtetem Stahl.</i></p> <p>4 papeleras con sujeta bolsas, acero barnizado.</p>	<p>CHF 1.048 (4 pz.) (CHF 262 cad.)</p> <p>(Prezzo speciale per 4 pz. imballati singolarmente) (Special price for 4 pcs. individually packaged) (Prix spécial pour 4 pièces emballés individuellement) (Sonderpreis für 4 Stücke einzeln verpackt) (Precio especial para 4 pzs empacquetados individualmente)</p>

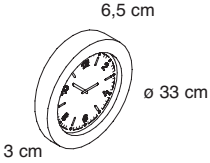
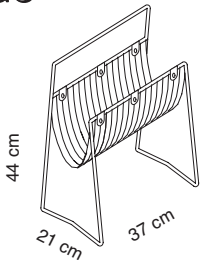

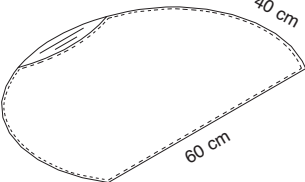
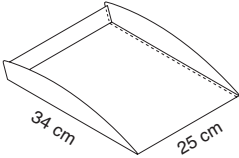
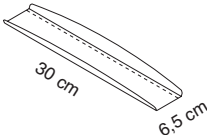
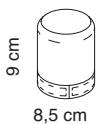
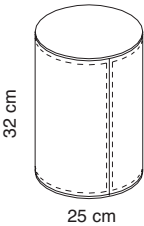

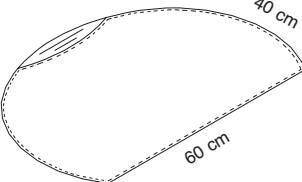
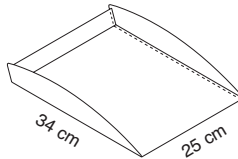
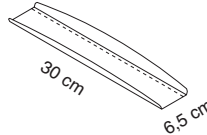
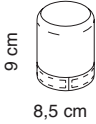
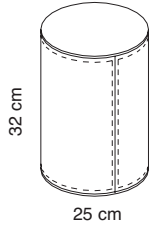
	ACCESSORI			PREZZO PRICE PRIX
	ARTICOLO ITEM ARTICLE	COLORI COLOURS COULEURS	DESCRIZIONE DESCRIPTION DESCRIPTION	
TIME 	81474-GM	GM	Orologio da parete in tecnopolimero. <i>Wall clock in high-tech polymer.</i> Horloge murale en techno-polymère. <i>Wanduhren aus Technopolymer.</i> Reloje de pared de tecnopolimero.	CHF 131
RIGO 	8545-NGL	N	Portariviste in acciaio e espanso rigato nero. <i>Magazine rack in steel and black ribbed plastic foam.</i> Porte-revues en acier et expansé rayé noir. <i>Zeitschriftenständer aus Stahl geripptem, schwarzem Kunststoff.</i> Revistero en acero y material expandido negro.	CHF 127

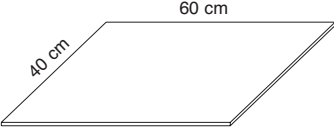
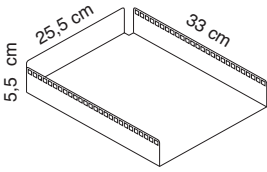
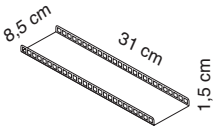
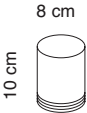
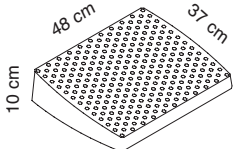
	EGO			PREZZO PRICE PRIX
	ARTICOLO ITEM ARTICLE	COLORI COLOURS COULEURS	DESCRIZIONE DESCRIPTION DESCRIPTION	
	80EG1	N/CU	<p>Sottomano nero finitura pelle ecologica colore cuoio.</p> <p><i>Black desk pad with detail in tan ecological leather.</i></p> <p>Sous-main noir finition cuir écologique</p> <p><i>Schwarze Schreibunterlage mit braunem Kunstledereinsatz.</i></p> <p>Bade negro con acabado en piel ecol. color cuero</p>	CHF 161
	80EG2	N/CU	<p>Portacorrispondenza verniciato nero con finitura pelle ecologica colore cuoio.</p> <p><i>Black epoxy-coated letter tray lined with tan ecological leather.</i></p> <p>Bac à courrier peint noir, finition cuir écologique</p> <p><i>Schwarze pulverlackierte Briefablage mit braunem Kunstledereinsatz.</i></p> <p>Bandeja acero negro con acabado en piel ecol. color cuero.</p>	CHF 101
	80EG3	N/CU	<p>Portaoggetti verniciato nero con finitura pelle ecologica colore cuoio.</p> <p><i>Black epoxy-coated pencil tray lined with tan ecological leather.</i></p> <p>Porte-objet peint noir finition cuir écologique</p> <p><i>Schwarze pulverlackierte Stifteschale mit braunem Kunstledereinsatz.</i></p> <p>Portaobjectos acero negro con acabado en piel ecol. color cuero.</p>	CHF 69
	80EG4	N/CU	<p>Portamatite verniciato nero con finitura pelle ecologica colore cuoio.</p> <p><i>Black epoxy-coated pencil pot covered with tan ecological leather.</i></p> <p>Porte-crayon peint noir finition cuir écologique</p> <p><i>Schwarzer pulverlackierter Stifteköcher mit brauner Kunstlederverkleidung.</i></p> <p>Portaalapiceros acero negro con acabado en piel ecol. color cuero.</p>	CHF 47
	80EG6	N/CU	<p>Cestino gettacarta verniciato nero con finitura pelle ecologica colore cuoio.</p> <p><i>Black epoxy-coated wastepaper bin covered with tan ecological leather.</i></p> <p>Corbeille à papier peint noir finition cuir écologique</p> <p><i>Schwarzer pulverlackierter Papierkorb mit brauner Kunstlederverkleidung.</i></p> <p>Papelera acero negro con acabado en piel ecol. color cuero.</p>	CHF 143

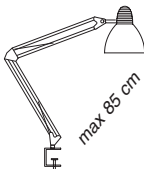
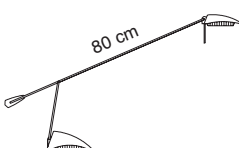
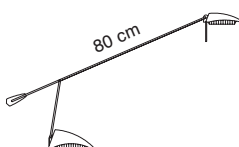
	EGO			PREZZO PRICE PRIX
	ARTICOLO ITEM ARTICLE	COLORI COLOURS COULEURS	DESCRIZIONE DESCRIPTION DESCRIPTION	
	80EG21	N	<p>Sottomano nero finitura pelle ecologica colore nero. <i>Black desk pad with detail in black ecological leather.</i></p> <p>Sous-main noir finition cuir écologique noir</p> <p><i>Schwarze Schreibunterlage mit schwarzem Kunstledereinsatz</i></p> <p>Bade negro con acabado en piel ecol. color negro</p>	CHF 161
	80EG22	GM/N	<p>Portacorrispondenza verniciato GM con finitura pelle ecologica colore nero. <i>Metallic grey epoxy-coated letter tray lined with black ecological leather.</i></p> <p>Bac à courrier peint GM finition cuir écologique noir</p> <p><i>Graumetallic pulverlackierte Briefablage mit schwarzem Kunstledereinsatz.</i></p> <p>Bandeja acero negro con acabado en piel ecol. color negro.</p>	CHF 101
	80EG23	GM/N	<p>Portaoggetti verniciato GM con finitura pelle ecologica colore nero. <i>Metallic grey epoxy-coated pencil tray lined with Black ecological leather.</i></p> <p>Porte-objet peint GM finition cuir écologique noir</p> <p><i>Graumetallic pulverlackierte Stifteschale mit scharzem Kunstledereinsatz.</i></p> <p>Portaobjectos acero negro con acabado en piel ecol. color negro.</p>	CHF 69
	80EG24	GM/N	<p>Portamatite verniciato GM con finitura pelle ecologica colore nero. <i>Metallic grey epoxy-coated pencil pot covered with Black ecological leather.</i></p> <p>Port-crayon peint GM finition cuir écologique noir</p> <p><i>Graumetallic pulverlackierter Stifteköcher mit schwarzer Kunstlederverkleidung.</i></p> <p>Portaolapiceros acero negro con acabado en piel ecol. color negro.</p>	CHF 47
	80EG26	N	<p>Cestino gettacarta in acciaio verniciato con finitura pelle ecologica colore nero. <i>Epoxy-coated steel wastepaper bin covered with black ecological leather.</i></p> <p>Corbeille à papier en acier peint finition cuir écologique noir</p> <p><i>Pulverlackierter Papierkorb mit schwarzer Kunstlederverkleidung.</i></p> <p>Papelera acero negro con acabado en piel ecol. color negro</p>	CHF 143

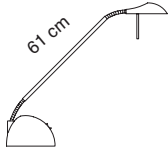
	ACCESSORI			PREZZO PRICE PRIX
	ARTICOLO ITEM ARTICLE	COLORI COLOURS COULEURS	DESCRIZIONE DESCRIPTION DESCRIPTION	
	80110	N	<p>Sottomano in espanso. <i>Polyurethane desk pad.</i> Sous-main en expansé <i>Schreibunterlage aus Schaumstoff</i> Bade en expandido</p> <p>(Confezione da 2 pezzi - <i>Set of 2 pcs</i> - Set 2 pièces - Set mit 2 Stücke - Set 2 pzs)</p>	<p>CHF 88</p> <p>(Prezzo per 2 pz) (Price for 2 pcs) (Prix pour 2 pcs) (Preis für 2 Stücke) (Precio para 2 pzs)</p>
	80100	N GM	<p>Portacorrispondenza impilabile verniciato con polveri epossidiche. <i>Epoxy-coated steel stackable letter tray.</i> Bac à courrier superposable peint époxy <i>Briefkörbe, pulverlackiertes Lochblech, stapelbar</i> Bandeja apilable en acero barnizado epoxi.</p> <p>(Supporti in tecnopolimero inclusi - <i>Avec entretoise - High-tech polymer spacers included - Stapelverbinder inklusive - Soportes incluidos</i>)</p>	<p>CHF 37</p>
	80102	N GM	<p>Portaoggetti verniciato con polveri epossidiche. <i>Epoxy-coated steel pencil tray.</i> Porte-objet peint époxy <i>Stifteschale, pulverlackiertes Lochblech</i> Portaobjectos en acero barnizado epoxi.</p>	<p>CHF 27</p>
	80104	N GM	<p>Portamatite verniciato con polveri epossidiche. Base in gomma. <i>Epoxy-coated steel pencil pot with rubber base.</i> Porte-crayon peint époxy. Base en caoutchouc <i>Stifteköcher, pulverlackiertes Lochblech mit Gummiboden</i> Portalapiceros en acero barnizado epoxi. Base en goma.</p>	<p>CHF 23</p>
	80400	GRIGIO ANTRACITE DARK GREY GRIS FONCE' DUNKEL GRAU GRIS ANTRACITA	<p>Poggiapiedi in tecnopolimero <i>High-tech polymer foot rest</i> Repose-pied en technopolymère <i>Fusstütze aus Kunststoff</i> Reposapies en tecnopolimero</p> <p>(Confezione da 2 pezzi - <i>Set of 2 pcs</i> - Set 2 pièces - Set mit 2 Stücke - Set 2 pzs)</p> <p>(Conforme al D.L.626) (Complies with current Italian health and safety regulations)</p>	<p>CHF 51</p> <p>(Prezzo per 1 pz) (Price for 1 pcs) (Prix pour 1 pcs) (Preis für 1 Stücke) (Precio para 1 pzs)</p>

Creando	LUCI			PREZZO PRICE PRIX
	ARTICOLO ITEM ARTICLE	COLORI COLOURS COULEURS	DESCRIZIONE DESCRIPTION DESCRIPTION	
JOB 	81848-GM	GM	<p>Lampada a incandescenza 230V-60W o fluorescente a risparmio energetico max12W L. max. lampadina 110 mm</p> <p>Incandescent lamp 230V-60W or compact energy saving fluorescent max. 12W, max. length of the bulbs 110 mm</p> <p>Lampe à incandescence 230V-60W ou fluorescente compacte max 12W, longueur max. de l'ampoule 110 mm</p> <p>Lámpara incandescente 230V-60W o fluorescente de ahorro energético max.12W L. max.de la bombilla 110 mm</p> <p>Leuchte 230V-60W (weissglühend) oder Energiesparlampe max. 12W, maximale Glühbirnenlänge 110 mm</p>	<p>CHF 78</p> <p>E</p>
	81848/4-GM	GM	<p>4 lampade a incandescenza 230V-60W o fluorescente a risparmio energetico max12W L. max. lampadina 110 mm</p> <p>4 incandescent lamps 230V-60W or compact energy saving fluorescent max. 12W, max.length of the bulbs 110 mm</p> <p>4 lampes à incandescence 230V-60W ou fluorescente compacte max 12W, longueur max. de l'ampoule 110 mm</p> <p>4 Leuchte 230V-60W (weissglühend) oder Energiesparlampe max. 12W, maximale Glühbirnenlänge 110 mm</p> <p>4 lámparas incandescente 230V-60W o fluorescente de ahorro energético max.12W L. max.de la bombilla 110 mm</p>	<p>CHF 276 (4 pz.) (CHF 69 cad.)</p> <p>E</p> <p>(Prezzo speciale per 4 pz. imballati singolarmente) (Special price for 4 pcs. individually packaged) (Prix spécial pour 4 pièces emballés individuellement) (Sonderpreis für 4 Stücke einzeln verpackt) (Precio especial para 4 pzs empacquetados individualmente)</p>
BIRDY 	80303-GM	GM	<p>Lampada alogena da tavolo 12V - 50W doppia intensità di luce.</p> <p>Halogen desk lamp12V - 50W dual intensity.</p> <p>Lampe halogène de bureau 12V-50W double intensité</p> <p>Halogen Tischleuchte 12V – 50 W mit 2-Lichtstärken.</p> <p>Lámpara halogena de mesa 12V-50W doble intensidad.</p> <p>(Lampadina inclusa - Bulb included - Avec ampoule - Leuchtmittel inklusive - Bombilla incluida)</p>	<p>CHF 283</p> <p>E+L</p>
	80303/4-GM	GM	<p>Lampada alogena da tavolo 12V - 50W doppia intensità di luce.</p> <p>Halogen desk lamp12V - 50W dual intensity.</p> <p>Lampe halogène de bureau 12V-50W double intensité</p> <p>Halogen Tischleuchte 12V – 50 W mit 2-Lichtstärken.</p> <p>Lámpara halogena de mesa 12V-50W doble intensidad.</p> <p>(Lampadina inclusa - Bulb included - Avec ampoule - Leuchtmittel inklusive - Bombilla incluida)</p>	<p>CHF 940 (4 pz.) (CHF 235 cad.)</p> <p>E+L</p> <p>(Prezzo speciale per 4 pz. imballati singolarmente) (Special price for 4 pcs. individually packaged) (Prix spécial pour 4 pièces emballés individuellement) (Sonderpreis für 4 Stücke einzeln verpackt) (Precio especial para 4 pzs empacquetados individualmente)</p>
BIRDY 	80303	N	<p>Lampada alogena da tavolo 12V - 50W doppia intensità di luce.</p> <p>Halogen desk lamp12V - 50W dual intensity.</p> <p>Lampe halogène de bureau 12V-50W double intensité</p> <p>Halogen Tischleuchte 12V – 50 W mit 2-Lichtstärken.</p> <p>Lámpara halogena de mesa 12V-50W doble intensidad.</p> <p>(Lampadina inclusa - Bulb included - Avec ampoule - Leuchtmittel inklusive - Bombilla incluida)</p>	<p>CHF 283</p> <p>E+L</p>
	80303/4	N	<p>4 lampade alogene da tavolo 12V - 50W doppia intensità di luce.</p> <p>4 halogen desk lamps 12V - 50W dual intensity.</p> <p>4 lampes halogènes de bureau 12V-50W double intensité</p> <p>4 halogen Tischleuchte 12V – 50 W mit 2-Lichtstärken.</p> <p>4 lámparas halogenas de mesa 12V-50W doble intensidad.</p> <p>(Lampadina inclusa - Bulb included - Avec ampoule - Leuchtmittel inklusive - Bombilla incluida)</p>	<p>CHF 940 (4 pz.) (CHF. 235 cad.)</p> <p>E+L</p> <p>(Prezzo speciale per 4 pz. imballati singolarmente) (Special price for 4 pcs. individually packaged) (Prix spécial pour 4 pièces emballés individuellement) (Sonderpreis für 4 Stücke einzeln verpackt) (Precio especial para 4 pzs empacquetados individualmente)</p>

	LUCI			PREZZO PRICE PRIX
	ARTICOLO ITEM ARTICLE	COLORI COLOURS COULEURS	DESCRIZIONE DESCRIPTION DESCRIPTION	
SMART 	80305-GM	GM	Lampada alogena da tavolo 12V - 50W doppia intensità di luce. <i>Halogen desk lamp 12V - 50W dual intensity.</i> Lampe halogène de bureau 12V-50W double intensité <i>Halogen Tischleuchte 12V – 50 W mit 2-Lichtstärken.</i> Lámpara halogena de mesa 12V-50W doble intensidad. (Lampadina inclusa - <i>Bulb included</i> - Avec ampoule - <i>Leuchtmittel inklusive</i> - Bombilla incluida)	CHF 166 E+L
HIT 	80351-N	N	Lampada da terra alogena 220V - 150W o fluorescente compatta max. 30W <i>Free-standing 220V - 150W halogen lamp or compact energy saving fluorescent max 30W</i> Lampe halogène 220V - 150W ou fluorescente compacte max. 30W <i>Halogen Stehleuchte 220V - 150W oder Energiesparlampe max 30W</i> Lampara de pie halogena 220V - 150W o fluorescente de haorro energetico max. 30W	CHF 475 E
HIT 	80351-C	CR	Lampada da terra alogena 220V - 150W o fluorescente compatta max. 30W <i>Free-standing 220V - 150W halogen lamp or compact energy saving fluorescent max 30W</i> Lampe halogène 220V - 150W ou fluorescente compacte max. 30W <i>Halogen Stehleuchte 220V - 150W oder Energiesparlampe max 30W</i> Lampara de pie halogena 220V - 150W o fluorescente de haorro energetico max. 30W	CHF 595 E
BOB 	80353-N	N	Lampada da terra alogena 220V - 150W o fluorescente compatta max. 30W <i>Free-standing 220V - 150W halogen lamp or compact energy saving fluorescent max 30W</i> Lampe halogène 220V - 150W ou fluorescente compacte max. 30W <i>Halogen Stehleuchte 220V - 150W oder Energiesparlampe max 30W</i> Lampara de pie halogena 220V - 150W o fluorescente de haorro energetico max. 30W	CHF 454 E