

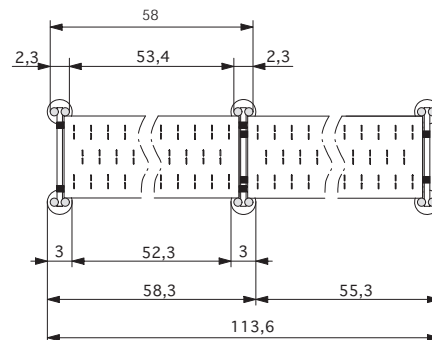

Creando

NEXT 32 & NEXT 45

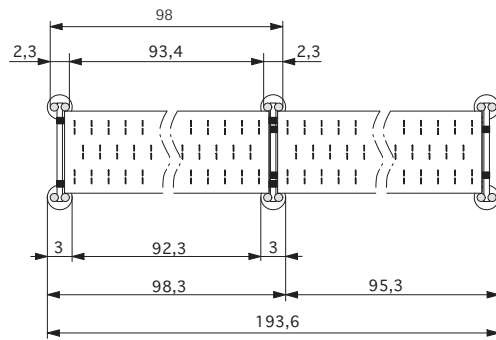
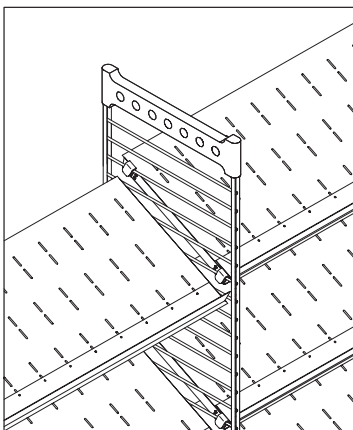
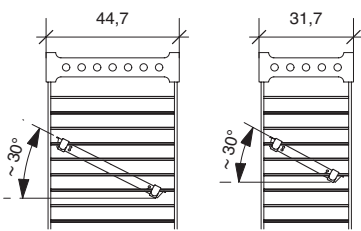
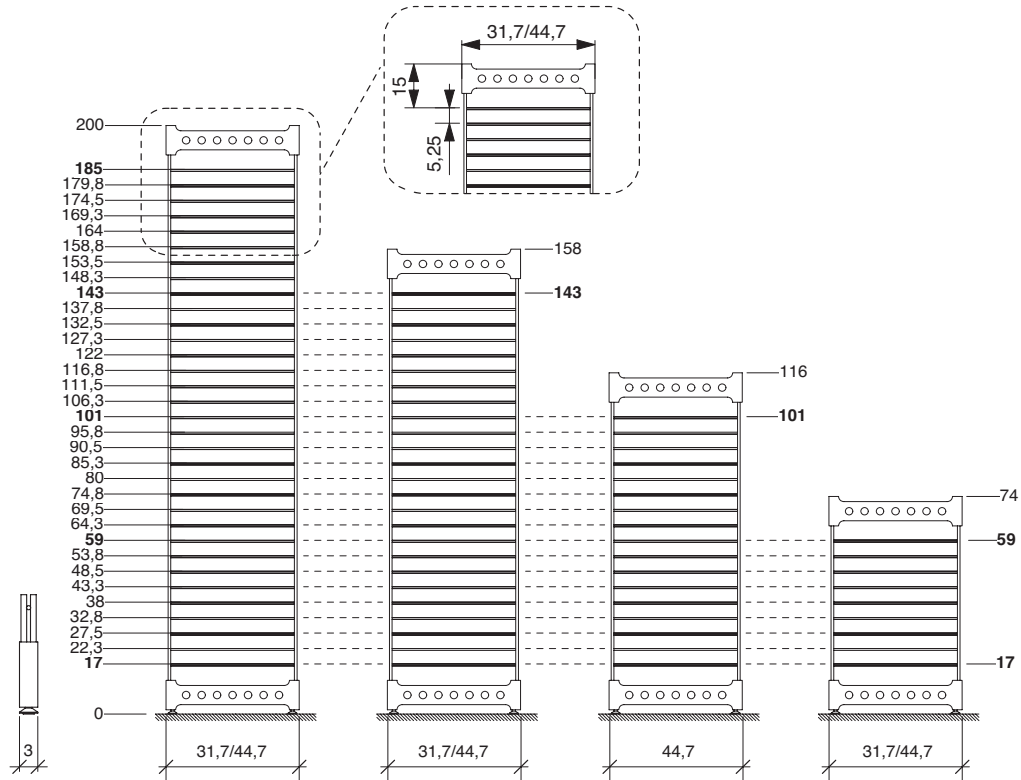

Dimensioni in cm - Dimensions in cm - Dimensions en cm - Dimensionen in cm - Dimensiones en cm

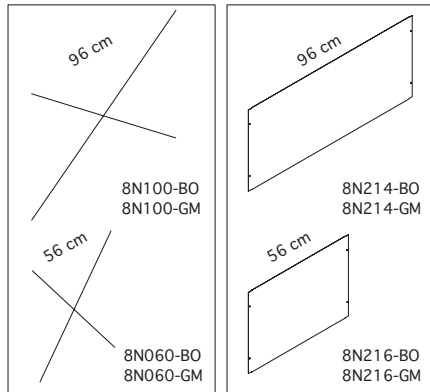

NEXT 32 & NEXT 45



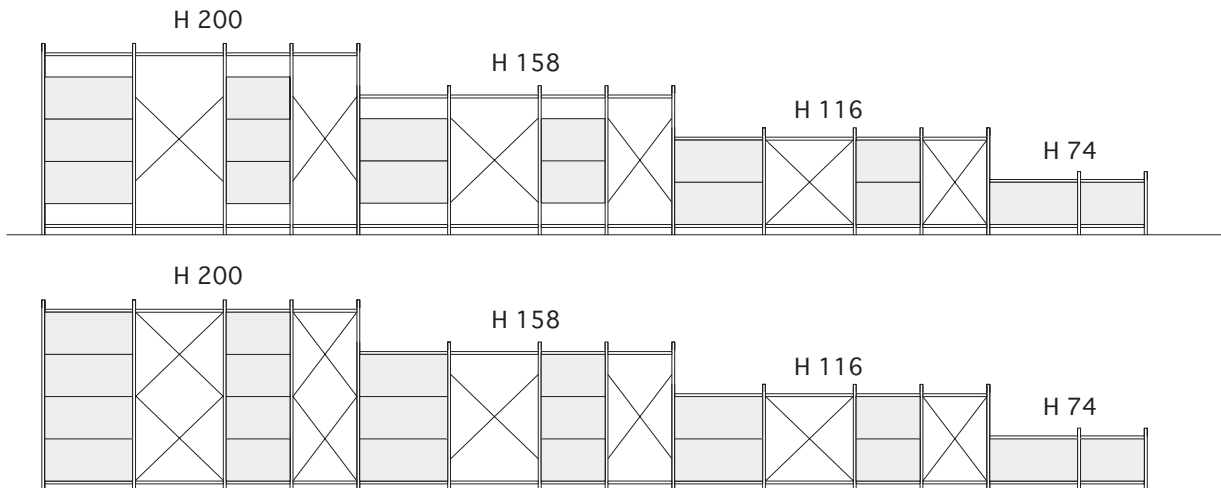

	MIN.	MAX.	MIN.	MAX.
H 200	1	2	3	4
H 158	1	1	2	3
H 116	1	1	2	2
H 74	-	-	1	1



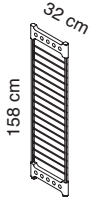
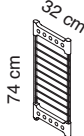
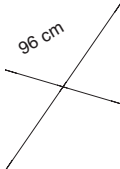
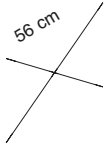
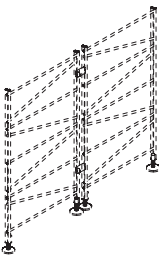

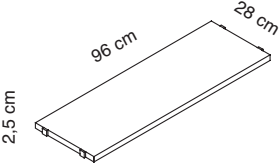
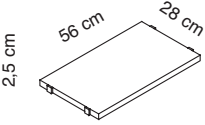
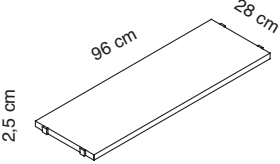
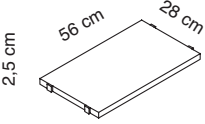
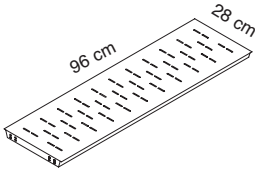
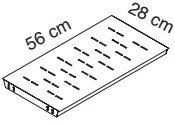
Numero minimo e massimo di elementi per modulo completo.
 Minimum and maximum number of load bearing elements for a complete module.
 Nombre minimum et maximum d'élément de soutien nécessaire pour une parfaite stabilité.
 Minimale und maximale Anzahl von benötigten Stabilisierungsteilen.
 Numero maximo y minimo de elementos de carga para un modulo completo.

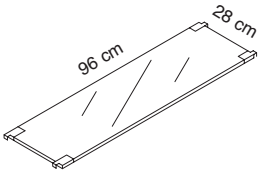
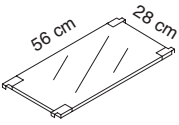
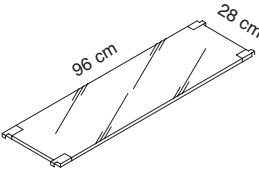
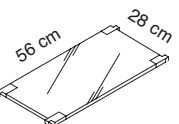
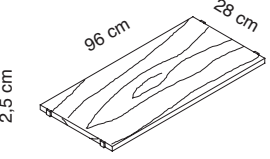
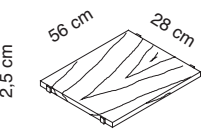

	NEXT 32			PREZZO PRICE PRIX
	ARTICOLO ITEM ARTICLE	COLORI COLOURS COULEURS	DESCRIZIONE DESCRIPTION DESCRIPTION	
	8N320-BO	BO	Montante in acciaio verniciato con polveri epossidiche 200 x 32 cm. <i>Epoxy-coated steel lateral upright 200 x 32 cm.</i>	CHF 167
	8N320-GM	GM	Montant en acier peint époxy 200 x 32 cm <i>Pulverlackiertes Seitenteil 200 x 32 cm.</i> Lateral en acero barnizado 200 x 32 cm. (Piedino regolabile incluso - Adjustable foot included - Avec pied réglable - inklusive verstellbarem Fuss - Pie regulable incluido)	
	8N311-BO	BO	Montante in acciaio verniciato con polveri epossidiche 158 x 32 cm. <i>Epoxy-coated steel lateral upright 158 x 32 cm.</i>	CHF 155
	8N311-GM	GM	Montant en acier peint époxy 158 x 32 cm <i>Pulverlackiertes Seitenteil 158 X 32 cm.</i> Lateral en acero barnizado 158 x 32 cm. (Piedino regolabile incluso - Adjustable foot included - Avec pied réglable - inklusive verstellbarem Fuss - Pie regulable incluido)	
	8N307-BO	BO	Montante in acciaio verniciato con polveri epossidiche 74 x 32 cm. <i>Epoxy-coated steel lateral upright 74 x 32 cm.</i>	CHF 108
	8N307-GM	GM	Montant en acier peint époxy 74 x 32 cm . <i>Pulverlackiertes Seitenteil 74 x 32 cm.</i> Lateral en acero barnizado 74 x 32 cm. (Piedino regolabile incluso - Adjustable foot included - Avec pied réglable - inklusive verstellbarem Fuss - Pie regulable incluido)	
	8N100-BO	BO	Crociere in acciaio verniciato con polveri epossidiche per ripiani lungh. 96 cm <i>Epoxy-coated steel crossbraces for shelves width 96 cm.</i>	CHF 55
	8N100-GM	GM	Croisillions en acier peint époxy pour rayons 96 cm <i>Pulverlackiertes Stabilisierungskreuz für Regale 96 cm.</i> Cruceta trasera en acero barnizado con polvos epoxidicos para estantes de 96 cm (Viti incluse - Screws included - Avec vis - Schrauben inklusive - Tornillos incluidos)	
	8N060-BO	BO	Crociere in acciaio verniciato con polveri epossidiche per ripiani lungh. 56 cm <i>Epoxy-coated steel crossbraces for shelves width 56 cm.</i>	CHF 53
	8N060-GM	GM	Croisillions en acier peint époxy pour rayons 56 cm <i>Pulverlackiertes Stabilisierungskreuz für Regale 56 cm.</i> Cruceta trasera en acero barnizado con polvos epoxidicos para estantes de 56 cm (Viti incluse - Screws included - Avec vis - Schrauben inklusive - Tornillos incluidos)	
	80646		Coppia giunti per unione bifronte <i>2 Joints for side up-right connection</i> 2 Joints pour accouplement bifrontal <i>Verbindungssatz</i> Par de juntas para connexion (Confezione da 2 pezzi - Set of 2 pcs - Set 2 pièces - Set mit 2 Stücke - Set 2 pzs)	CHF 31 (Prezzo per 2 pz) (Price for 2 pcs) (Prix pour 2 pcs) (Preis für 2 Stücke) (Precio para 2 pzs)

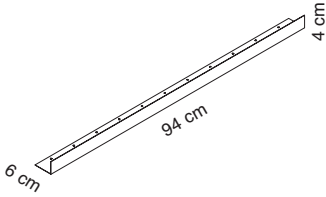
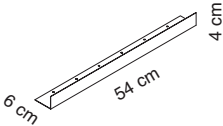
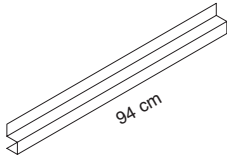
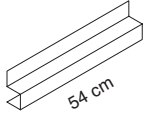
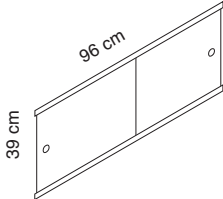
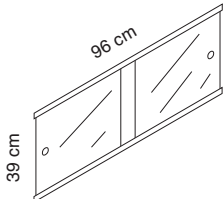

	NEXT 32			PREZZO PRICE PRIX
	ARTICOLO ITEM ARTICLE	COLORI COLOURS COULEURS	DESCRIZIONE DESCRIPTION DESCRIPTION	
	Supporti bianchi e grigi White and grey supports Supports blancs et gris Weisse und Graue Halter Soportes blancos y grises 8N3410-BO	BO	Ripiani in melaminico bianco 96X28 cm. <i>White melamine shelves 96X28 cm.</i> Tablettes en melaminé blanc 96X28 cm. <i>Fachböden aus weissem Melamin 96X28 cm</i> Estante acabado en melamina blanco 96X28 cm (Supporti per montaggio inclusi - <i>Couplings included</i> - Avec joints - <i>Inklusive Halterungen</i> - Soportes incluidos)	CHF 81
	Supporti bianchi e grigi White and grey supports Supports blancs et gris Weisse und Graue Halter Soportes blancos y grises 8N3460-BO	BO	Ripiani in melaminico bianco 56X28 cm. <i>White melamine shelves 56X28 cm.</i> Tablettes en melaminé blanc 56X28 cm. <i>Fachböden aus weissem Melamin 58X28 cm</i> Estante acabado en melamina blanco 56X28 cm (Supporti per montaggio inclusi - <i>Couplings included</i> - Avec joints - <i>Inklusive Halterungen</i> - Soportes incluidos)	CHF 64
	Supporti bianchi - White supports - Supports blancs - Weisse Halter - Soportes blancos 8N3312-BO	BO	Ripiani in acciaio verniciato cm 28 x 96 <i>Epoxy-coated steel shelves 28 x 96 cm.</i> Rayons en tôle d'acier peint époxy 28 x 96 cm <i>Pulverlackierter Fachboden 28 x 96 cm.</i> Esatntes en acero barnizado con polvos epoxidicos de 28 x 96 cm (Supporti per montaggio inclusi - <i>Couplings included</i> - Avec joints - <i>Inklusive Halterungen</i> - Soportes incluidos)	CHF 88
	Supporti grigi - Grey supports - Supports gris - Graue Halter - Soportes grises 8N3312-GM	GM		
	Supporti bianchi - White supports - Supports blancs - Weisse Halter - Soportes blancos 8N3362-BO	BO	Ripiani in acciaio verniciato cm 28 x 56. <i>Epoxy-coated steel shelves 28 x 56 cm.</i> Rayons en tôle d'acier peint époxy 28 x 56 cm <i>Pulverlackierter Fachboden 28 x 56 cm.</i> Esatantes en acero barnizado con polvos epoxidicos de 28 x 56 cm. (Supporti per montaggio inclusi - <i>Couplings included</i> - Avec joints - <i>Inklusive Halterungen</i> - Soportes incluidos)	CHF 78
	Supporti grigi - Grey supports - Supports gris - Graue Halter - Soportes grises 8N3362-GM	GM		
	Supporti bianchi - White supports - Supports blancs - Weisse Halter - Soportes blancos 8N3310-BO	BO	Ripiani forati in acciaio verniciato 96X28 cm. <i>Perforated steel shelves 96x28 cm.</i> Rayons en tôle d'acier perforé peint époxy 96x28 cm <i>Pulverlackierter Fachboden aus Stahl 96x28 cm.</i> Estantes en acero barnizado con polvos epoxidicos de 96x28 cm. (Supporti per montaggio inclusi - <i>Couplings included</i> - Avec joints - <i>Inklusive Halterungen</i> - Soportes incluidos)	CHF 127
	Supporti grigi - Grey supports - Supports gris - Graue Halter - Soportes grises 8N3310-GM	GM		
	Supporti bianchi - White supports - Supports blancs - Weisse Halter - Soportes blancos 8N3360-BO	BO	Ripiani forati in acciaio verniciato 56x28 cm. <i>Perforated steel shelves 56x28 cm.</i> Rayons en tôle d'acier perforé peint époxy 56x28 cm <i>Pulverlackierter Fachboden aus Stahl 56x28 cm.</i> Estantes en acero barnizado con polvos epoxidicos de 56x28 cm. (Supporti per montaggio inclusi - <i>Couplings included</i> - Avec joints - <i>Inklusive Halterungen</i> - Soportes incluidos)	CHF 117
	Supporti grigi - Grey supports - Supports gris - Graue Halter - Soportes grises 8N3360-GM	GM		

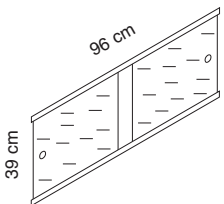
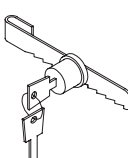
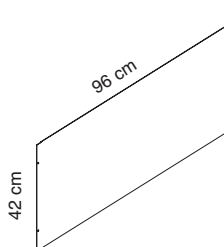
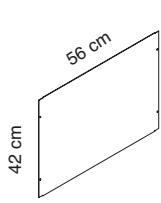
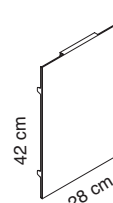
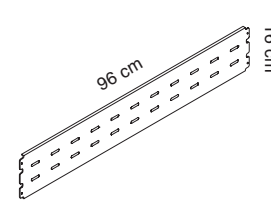

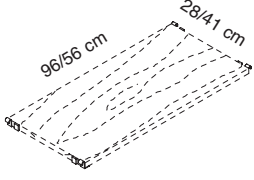
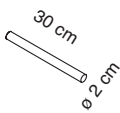
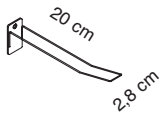
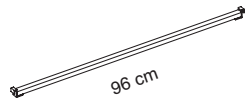
	NEXT 32			PREZZO PRICE PRIX
	ARTICOLO ITEM ARTICLE	COLORI COLOURS COULEURS	DESCRIZIONE DESCRIPTION DESCRIPTION	
	Supporti bianchi - White supports - Supports blancs - Weisse Halter - Soportes blancos 8N3710-BO	T	Ripiani in vetro temperato trasparente spessore 8 mm 96X28 cm. <i>8 mm tempered transparent glass shelves 96x28 cm</i> Tablettes en verre trempé transparent épaisseur 8 mm. 96X28 cm.	CHF 144
	Supporti grigi - Grey supports - Supports gris - Graue Halter - Soportes grises 8N3710-GR	T	<i>Regalböden aus gehärtetem Sicherheitsglas, transparent, Stärke 8 mm. 96x28 cm.</i> Estantes en vidrio templado transparente espesor 8 mm. 96X28 cm. (Supporti per montaggio inclusi - Couplings included - Avec joints - Inklusive Halterungen - Soportes incluidos)	
	Supporti bianchi - White supports - Supports blancs - Weisse Halter - Soportes blancos 8N3760-BO	T	Ripiani in vetro temperato trasparente spessore 8 mm 56x28 cm. <i>8 mm tempered transparent glass shelves 56x28 cm</i> Tablettes en verre trempé transparent épaisseur 8 mm. 56x28 cm.	CHF 139
	Supporti grigi - Grey supports - Supports gris - Graue Halter - Soportes grises 8N3760-GR	T	<i>Regalböden aus gehärtetem Sicherheitsglas, transparent, Stärke 8 mm. 56x28 cm.</i> Estantes en vidrio templado transparente espesor 8 mm. 56x28 cm. (Supporti per montaggio inclusi - Couplings included - Avec joints - Inklusive Halterungen - Soportes incluidos)	
	Supporti bianchi - White supports - Supports blancs - Weisse Halter - Soportes blancos 8N3610-BO	AC	Ripiani in vetro temperato acidato spessore 8 mm 96X28 cm. <i>8 mm tempered satin glass shelves 96x28 cm</i> Tablettes en verre trempé satiné épaisseur 8 mm. 96X28 cm.	CHF 185
	Supporti grigi - Grey supports - Supports gris - Graue Halter - Soportes grises 8N3610-GR	AC	<i>Regalböden aus gehärtetem Sicherheitsglas, satiniert, Stärke 8 mm. 96x28 cm.</i> Estantes en vidrio templado satinado espesor 8 mm. 96X28 cm. (Supporti per montaggio inclusi - Couplings included - Avec joints - Inklusive Halterungen - Soportes incluidos)	
	Supporti bianchi - White supports - Supports blancs - Weisse Halter - Soportes blancos 8N3660-BO	AC	Ripiani in vetro temperato acidato spessore 8 mm 56x28 cm. <i>8 mm tempered satin glass shelves 56x28 cm</i> Tablettes en verre trempé satiné épaisseur 8 mm. 56x28 cm.	CHF 178
	Supporti grigi - Grey supports - Supports gris - Graue Halter - Soportes grises 8N3660-GR	AC	<i>Regalböden aus gehärtetem Sicherheitsglas, satiniert, Stärke 8 mm. 56x28 cm.</i> Estantes en vidrio templado satinado espesor 8 mm. 56x28 cm. (Supporti per montaggio inclusi - Couplings included - Avec joints - Inklusive Halterungen - Soportes incluidos)	
 <p>** Articolo disponibile fino ad esaurimento scorte ** Item available until stock lasts</p>	Supporti bianchi e grigi - White and grey supports - Supports blancs et gris - Weisse und Graue Halter - Soportes blancos y grises 8N3510		Ripiani in melaminico finitura rovere sbiancato 96X28 cm. <i>Bleached oak melamine shelves 96x28 cm.</i> Tablettes en melaminé finition rouvre blancs 96x28 cm. <i>Fachböden aus Melamin, Ausführung Eichenholz gebleicht 96x28 cm</i> Estante acabado en melamina de roble blanqueada 96x28 cm (Supporti per montaggio inclusi - Couplings included - Avec joints - Inklusive Halterungen - Soportes incluidos)	CHF 85
 <p>** Articolo disponibile fino ad esaurimento scorte ** Item available until stock lasts</p>	Supporti bianchi e grigi - White and grey supports - Supports blancs et gris - Weisse und Graue Halter - Soportes blancos y grises 8N3560		Ripiani in melaminico finitura rovere sbiancato 56x28 cm. <i>Bleached oak melamine shelves 56x28 cm.</i> Tablettes en melaminé finition rouvre blancs 56x28 cm. <i>Fachböden aus Melamin, Ausführung Eichenholz gebleicht 56x28 cm</i> Estante acabado en melamina de roble blanqueada 56x28 cm (Supporti per montaggio inclusi - Couplings included - Avec joints - Inklusive Halterungen - Soportes incluidos)	CHF 71

	NEXT 32			PREZZO PRICE PRIX
	ARTICOLO ITEM ARTICLE	COLORI COLOURS COULEURS	DESCRIZIONE DESCRIPTION DESCRIPTION	
	8N210-BO	BO	<p>Coppia bordi a L in acciaio verniciato con polveri epossidiche per ripiani 8N3310-BO / 8N3310-GM</p> <p><i>Pair of epoxy-coated L-shaped steel profiles for shelves for shelf 8N3310-BO / 8N3310-GM</i></p> <p>Paire bords en L en acier peint époxy pour tablette 8N3310-BO / 8N3310-GM</p>	<p>CHF 94</p> <p>(Prezzo per 2 pz) (Price for 2 pcs) (Prix pour 2 pcs) (Preis für 2 Stücke) (Precio para 2 pzs)</p>
	8N210-GM	GM	<p><i>2 Pulverlackiertes L-Profil für Fachboden für 8N3310-BO / 8N3310-GM</i></p> <p>Set 2 pzs perfil frontal para estantes 8N3310-BO / 8N3310-GM</p>	
	8N212-BO	BO	<p>Coppia bordi a L in acciaio verniciato con polveri epossidiche per ripiani 8N3360-BO / 8N3360-GM</p> <p><i>Pair of epoxy-coated L-shaped steel profiles for shelves for shelf 8N3360-BO / 8N3360-GM</i></p> <p>Paire bords en L en acier peint époxy pour tablette 8N3360-BO / 8N3360-GM</p>	<p>CHF 91</p> <p>(Prezzo per 2 pz) (Price for 2 pcs) (Prix pour 2 pcs) (Preis für 2 Stücke) (Precio para 2 pzs)</p>
	8N212-GM	GM	<p><i>2 Pulverlackiertes L-Profil für Fachboden für 8N3360-BO / 8N3360-GM</i></p> <p>Set 2 pzs perfil frontal para estantes 8N3360-BO / 8N3360-GM</p>	
	8N220-BO	BO	<p>Coppia bordi a L in acciaio verniciato con polveri epossidiche per ripiani 8N3312-BO / 8N3312-GM</p> <p><i>Pair of epoxy-coated L-shaped steel profiles for shelves for shelf 8N3312-BO / 8N3312-GM</i></p> <p>Paire bords en L en acier peint époxy pour tablette 8N3312-BO / 8N3312-GM</p>	<p>CHF 48</p> <p>(Prezzo per 2 pz) (Price for 2 pcs) (Prix pour 2 pcs) (Preis für 2 Stücke) (Precio para 2 pzs)</p>
	8N220-GM	GM	<p><i>2 Pulverlackiertes L-Profil für Fachboden für 8N3312-BO / 8N3312-GM</i></p> <p>Set 2 pzs perfil frontal para estantes 8N3312-BO / 8N3312-GM</p>	
	8N222-BO	BO	<p>Coppia bordi a L in acciaio verniciato con polveri epossidiche per ripiani 8N3362-BO / 8N3362-GM</p> <p><i>Pair of epoxy-coated L-shaped steel profiles for shelves for shelf 8N3362-BO / 8N3362-GM</i></p> <p>Paire bords en L en acier peint époxy pour tablette 8N3362-BO / 8N3362-GM</p>	<p>CHF 45</p> <p>(Prezzo per 2 pz) (Price for 2 pcs) (Prix pour 2 pcs) (Preis für 2 Stücke) (Precio para 2 pzs)</p>
	8N222-GM	GM	<p><i>2 Pulverlackiertes L-Profil für Fachboden für 8N3362-BO / 8N3362-GM</i></p> <p>Set 2 pzs perfil frontal para estantes 8N3362-BO / 8N3362-GM</p>	
	8N201-BO	BO	<p>Coppia ante scorrevoli in acciaio verniciato per ripiano da 96 cm. Da utilizzare con piani 8N3310-BO / 8N3310-GM.</p> <p><i>Pair of epoxy-coated steel sliding doors for shelves width 96 cm. To be used with shelves 8N3310-BO / 8N3310-GM.</i></p> <p>Paire portes couliss. en acier peint pour rayon de 96 cm. A utiliser avec tablettes 8N3310-BO / 8N3310-GM.</p>	<p>CHF 213</p>
	8N201-GM	GM	<p><i>Paar pulverlackierte Schiebetüren für Böden 96 cm breit. Für Regalboden Art. 8N3310-BO / 8N3310-GM.</i></p> <p>Puertas correderas en acero barnizado 96 cm. Para ser utilizadas con estantes ref. 8N3310-BO / 8N3310-GM.</p>	
	8N203-BO	T	<p>Coppia ante scorrevoli in vetro temperato per ripiano da 96 cm. Da utilizzare con piani 8N3310-BO / 8N3310-GM.</p> <p><i>Pair of tempered glass sliding doors for shelves width 96 cm. To be used with shelves 8N3310-BO / 8N3310-GM.</i></p> <p>Paire portes coulissantes en verre trempé pour rayon de 96 cm. A utiliser avec tablettes 8N3310-BO / 8N3310-GM.</p>	<p>CHF 237</p>
	8N203-GM	T	<p><i>Paar Schiebetüren Klarglas für Böden 96 cm breit. Für Regalboden Art. 8N3310-BO / 8N3310-GM.</i></p> <p>Puertas correderas en cristal templado 96 cm. Para ser utilizadas con estantes ref. 8N3310-BO / 8N3310-GM.</p>	

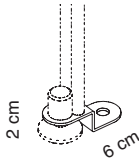
	NEXT 32			PREZZO PRICE PRIX
	ARTICOLO ITEM ARTICLE	COLORI COLOURS COULEURS	DESCRIZIONE DESCRIPTION DESCRIPTION	
	8N205-BO	AC	Coppia ante scorrevoli vetro temperato satinato per ripiano 96 cm. Da utilizzare con piani 8N3310-BO / 8N3310-GM . <i>Pair of satin tempered glass sliding doors for shelves 96 cm. To be used with shelves 8N3310-BO / 8N3310-GM.</i> Paire portes couliss. en verre satiné trempé pour rayon de 96 cm. A utiliser avec tablettes 8N3310-BO / 8N3310-GM . <i>Paar Schiebetüren Mattglas für Böden 96 cm breit. Für Regalboden Art. 8N3310-BO / 8N3310-GM.</i>	CHF 272
	8N205-GM	AC	Puertas correderas en cristal opaco templado 96 cm. Para ser utilizadas con estantes ref. 8N3310-BO / 8N3310-GM .	
	82659	CR	Serratura per ante scorrevoli in vetro. Solo per cod. 8N203-BO / 8N203-GM <i>Lock for glass sliding doors. Only for code 8N203-BO / 8N203-GM</i> Serrure pour portes coulissantes en verre. Seulement pour réf. 8N203-BO / 8N203-GM . <i>Schloß für Glasschiebetüren. Für Art. 8N203-BO / 8N203-GM</i> Cerradura para las puertas correderas cristal. Para ref. 8N203-BO / 8N203-GM	CHF 35
	8N214-BO	BO	Chiusura posteriore in lamiera di acciaio verniciato con polveri epossidiche lungh. 96 cm. <i>Epoxy-coated steel back panel width 96 cm.</i> Panneau arrière tôle d'acier peint époxy l. 96 cm <i>Rückwände aus beschichtetem Stahlblech 96 cm breit.</i>	CHF 132
	8N214-GM	GM	Cerradura trasera en acero barnizado epoxi. 96 cm (Viti incluse - <i>Screws included</i> - Avec vis - <i>Schrauben inklusive</i> - Tornillos incluidos)	
	8N216-BO	BO	Chiusura posteriore in lamiera di acciaio verniciato con polveri epossidiche lungh. 56 cm. <i>Epoxy-coated steel back panel width 56 cm.</i> Panneau arrière tôle d'acier peint époxy l. 56 cm <i>Rückwände aus beschichtetem Stahlblech 56 cm breit.</i>	CHF 130
	8N216-GM	GM	Cerradura trasera en acero barnizado epoxi. 56 cm (Viti incluse - <i>Screws included</i> - Avec vis - <i>Schrauben inklusive</i> - Tornillos incluidos)	
	8N3218-BO	BO	Coppia chiusure laterali esterne in lamiera di acciaio verniciato con polveri epossidiche 42x28 cm. <i>Pair of external lateral closing elements in epoxy-coated steel 42x28 cm.</i> Paire panneaux latéraux en tôle d'acier peint époxy 42x28 cm <i>Außenverkleidungen aus beschichtetem Stahlblech 42x28 cm breit.</i>	CHF 115 (Prezzo per 2 pz) (Price for 2 pcs) (Prix pour 2 pcs) (Preis für 2 Stücke) (Precio para 2 pzs)
	8N3218-GM	GM	Set 2 pzs cerraduras externas 42x28 cm (Confezione da 2 pezzi - <i>Set of 2 pcs</i> - Set 2 pièces - <i>Set mit 2 Stücke</i> - Set 2 pzs)	
	8N223-BO	BO	Supporto universale L. 96 cm <i>Universal support L 96 cm.</i> Support universel L 96 cm <i>Universaltraverse 96 cm breit.</i>	CHF 137
	8N223-GM	GM	Soporte universal L 96 cm	

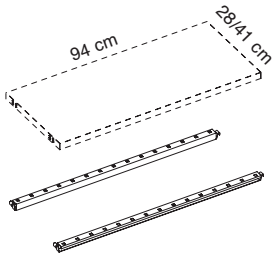
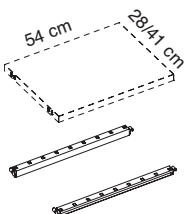
	NEXT 32			PREZZO PRICE PRIX
	ARTICOLO ITEM ARTICLE	COLORI COLOURS COULEURS	DESCRIZIONE DESCRIPTION DESCRIPTION	
	80674	GM	<p>Rinforzi per ripiani top di copertura posizionati ad altezza uguale o inferiore a 100 cm. Per cod. 8N3410-BO / 8N3460-BO / 8N3510 / 8N3560</p> <p><i>Strengthening for top shelves on units 100 cm high or lower. For codes 8N3410-BO / 8N3460-BO / 8N3510 / 8N3560</i></p> <p>Renforcement pour tablette dessus, en cas l'hauteur est 100 cm ou inférieure. Pur réf. 8N3410-BO / 8N3460-BO / 8N3510 / 8N3560</p> <p>Verstärkung für das Abschlusstablar bei einer Regalhöhe von oder unter 100 cm. Für Art. 8N3410-BO / 8N3460-BO / 8N3510 / 8N3560</p> <p><i>Refuerzo para estante superior situado a una altura de 100 cm o inferior. Para ref. 8N3410-BO / 8N3460-BO / 8N3510 / 8N3560</i></p> <p>(UNI EN 1727, EN 14073-2, EN 14073-3)</p>	CHF 21
	82763	CR	<p>Supporto in acciaio cromato <i>Chrome-plated support</i></p> <p>Support en acier chromé <i>Halter aus verchromtem Stahl</i></p> <p>Soporte en acero cromado</p>	CHF 36
	82765	CR	<p>Portablister in acciaio cromato <i>Chrome-plated blister holder</i></p> <p>Support en acier chromé <i>Blisterhalter aus verchromtem Stahl</i></p> <p>Portablister en acero cromado</p>	CHF 18
	80636	CR	<p>Barra orizzontale cromata portabiti 96 cm. <i>Chrome plated coat rail for shelves width 96 cm.</i></p> <p>Barre horizontale chromée portemanteau 96 cm <i>Verchromte Garderobenstange zur Anbringung an 96 cm breite Fachböden.</i></p> <p>Barra horizontal cromada para colgar de 96 cm.</p> <p>(Supporti per montaggio inclusi - <i>Couplings included</i> - Avec joints - <i>Inklusive Halterungen</i> - Soportes incluidos)</p>	CHF 142
	82578	N	<p>Passacavi in tecnopolimero. <i>High-tech polymer cable holder.</i></p> <p>Séparateurs de cablagés en polymère <i>Kunststoff-Kabelhalter.</i></p> <p>Pasacables en tecnopolimero.</p> <p>(Confezione da 8 pezzi - <i>Set of 8 pcs</i> - Set 8 pièces - <i>Set mit 8 Stücke</i> - Set 8 pzs)</p>	CHF 18 (Prezzo per 8 pz) (Price for 8 pcs) (Prix pour 8 pcs) (Preis für 8 Stücke) (Precio para 8 pzs)

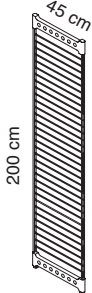
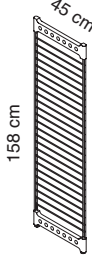
	NEXT 32			PREZZO PRICE PRIX
	ARTICOLO ITEM ARTICLE	COLORI COLOURS COULEURS	DESCRIZIONE DESCRIPTION DESCRIPTION	
	80644	GM	<p>Fissaggio a terra per montanti Next. <i>Floor fixing for Next uprights.</i></p> <p>Fixation au sol pour montants Next <i>Bodenbefestigung für Next Seitenteile.</i></p> <p>Fijacion a suelo para lateral Next</p> <p>(Confezione da 2 pezzi - <i>Set of 2 pcs</i> - Set 2 pièces - <i>Set mit 2 Stücke</i> - Set 2 pzs)</p>	<p>CHF 28</p> <p>(Prezzo per 2 pz) (Price for 2 pcs) (Prix pour 2 pcs) (Preis für 2 Stücke) (Precio para 2 pzs)</p>
	82996	N	<p>Coppia squadrette per unione montanti a 90° <i>Pair of joints for 90° side uprights connection</i></p> <p>Paire de joints pour juxtaposition mont.à 90° <i>Halterstücke für Eckkombinationen 90°</i></p> <p>Par de juntas para conexion laterales a 90°</p> <p>(Viti incluse - <i>Screws included</i> - Avec vis - <i>Schrauben inklusive</i> - Tornillos incluidos) (Confezione da 2 pezzi - <i>Set of 2 pcs</i> - Set mit 2 Stücke)</p>	<p>CHF 32</p> <p>(Prezzo per 2 pz) (Price for 2 pcs) (Prix pour 2 pcs) (Preis für 2 Stücke) (Precio para 2 pzs)</p>
	80670	GM	<p>Coppia rinforzi per ripiani top di copertura posizionati ad altezza uguale o inferiore a 100 cm. Per cod. 8N3312-BO / 8N3312-GM</p> <p><i>Strengthening for top shelves on units 100 cm high or lower.</i> <i>For codes 8N3312-BO / 8N3312-GM</i></p> <p>Renforcement pour tablette dessus, en cas l'hauteur est 100 cm ou inférieure. Pur réf. 8N3312-BO / 8N3312-GM</p> <p><i>Refuerzo para estante superior situado a una altura de 100 cm o inferior.</i> <i>Para ref. 8N3312-BO / 8N3312-GM</i></p> <p>Verstärkung für das Abschlusstablar bei einer Regalhöhe von oder unter 100 cm. Für Art. 8N3312-BO / 8N3312-GM</p> <p>(UNI EN 1727, EN 14073-2, EN 14073-3)</p>	<p>CHF 40</p>
	80672	GM	<p>Coppia rinforzi per ripiani top di copertura posizionati ad altezza uguale o inferiore a 100 cm. Per cod. 8N3362-BO / 8N3362-GM</p> <p><i>Strengthening for top shelves on units 100 cm high or lower.</i> <i>For codes 8N3362-BO / 8N3362-GM</i></p> <p>Renforcement pour tablette dessus, en cas l'hauteur est 100 cm ou inférieure. Pur réf. 8N3362-BO / 8N3362-GM</p> <p><i>Refuerzo para estante superior situado a una altura de 100 cm o inferior.</i> <i>Para ref. 8N3362-BO / 8N3362-GM</i></p> <p>Verstärkung für das Abschlusstablar bei einer Regalhöhe von oder unter 100 cm. Für Art. 8N3362-BO / 8N3362-GM</p> <p>(UNI EN 1727, EN 14073-2, EN 14073-3)</p>	<p>CHF 38</p>

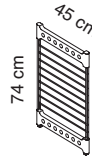
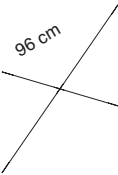
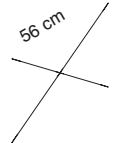

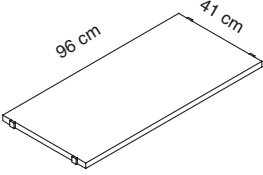
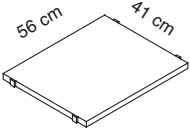
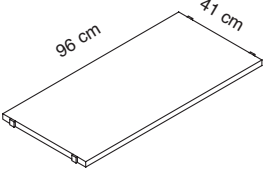
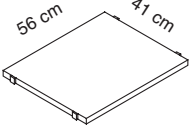
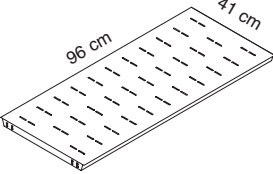
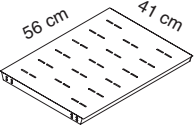
	NEXT 45			PREZZO PRICE PRIX
	ARTICOLO ITEM ARTICLE	COLORI COLOURS COULEURS	DESCRIZIONE DESCRIPTION DESCRIPTION	
	8N420-BO	BO	Montante in acciaio verniciato con polveri epossidiche 200 x 45 cm. <i>Epoxy-coated steel lateral upright 200 x 45 cm.</i>	CHF 187
	8N420-GM	GM	Montant en acier peint époxy 200 x 45 cm <i>Pulverlackiertes Seitenteil 200 x 45 cm.</i> Lateral en acero barnizado 200 x 45 cm. (Piedino regolabile incluso - Adjustable foot included - Avec pied réglable - inklusive verstellbarem Fuss - Pie regulable incluido)	
	8N416-BO	BO	Montante in acciaio verniciato con polveri epossidiche 158 x 45 cm. <i>Epoxy-coated steel lateral upright 158 x 45 cm.</i>	CHF 184
	8N416-GM	GM	Montant en acier peint époxy 158 x 45 cm . <i>Pulverlackiertes Seitenteil 158x 45 cm.</i> Lateral en acero barnizado 158 x 45 cm. (Piedino regolabile incluso - Adjustable foot included - Avec pied réglable - inklusive verstellbarem Fuss - Pie regulable incluido)	
	8N411-BO	BO	Montante in acciaio verniciato con polveri epossidiche 116 x 45 cm. <i>Epoxy-coated steel lateral upright 116 x 45 cm.</i>	CHF 160
	8N411-GM	GM	Montant en acier peint époxy 116 x 45 cm <i>Pulverlackiertes Seitenteil 116 X 45 cm.</i> Lateral en acero barnizado 116 x 45 cm. (Piedino regolabile incluso - Adjustable foot included - Avec pied réglable - inklusive verstellbarem Fuss - Pie regulable incluido)	
	8N407-BO	BO	Montante in acciaio verniciato con polveri epossidiche 74 x 45 cm. <i>Epoxy-coated steel lateral upright 74 x 45 cm.</i>	CHF 115
	8N407-GM	GM	Montant en acier peint époxy 74 x 45 cm <i>Pulverlackiertes Seitenteil 74 X 45 cm.</i> Lateral en acero barnizado 74 x 45 cm. (Piedino regolabile incluso - Adjustable foot included - Avec pied réglable - inklusive verstellbarem Fuss - Pie regulable incluido)	
	8N100-BO	BO	Crociere in acciaio verniciato con polveri epossidiche per ripiani lungh. 96 cm <i>Epoxy-coated steel crossbraces for shelves width 96 cm.</i>	CHF 55
	8N100-GM	GM	Croisillions en acier peint époxy pour rayons 96 cm <i>Pulverlackiertes Stabilisierungskreuz für Regale 96 cm.</i> Cruceta trasera en acero barnizado con polvos epoxidicos para estantes de 96 cm (Viti incluse - Screws included - Avec vis - Schrauben inklusive - Tornillos incluidos)	
	8N060-BO	BO	Crociere in acciaio verniciato con polveri epossidiche per ripiani lungh. 56 cm <i>Epoxy-coated steel crossbraces for shelves width 56 cm.</i>	CHF 53
	8N060-GM	GM	Croisillions en acier peint époxy pour rayons 56 cm <i>Pulverlackiertes Stabilisierungskreuz für Regale 56 cm.</i> Cruceta trasera en acero barnizado con polvos epoxidicos para estantes de 56 cm (Viti incluse - Screws included - Avec vis - Schrauben inklusive - Tornillos incluidos)	

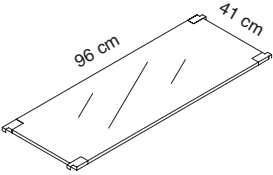
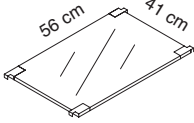
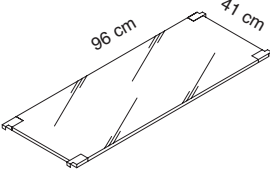
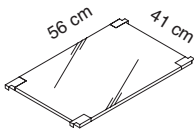
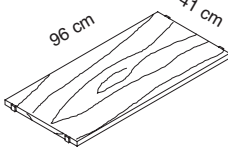
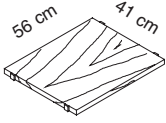

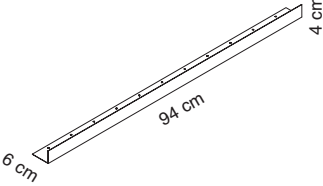
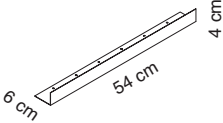
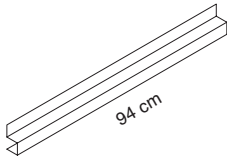
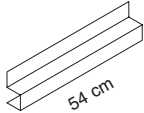
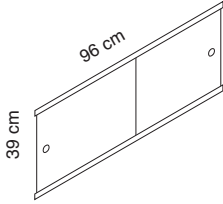
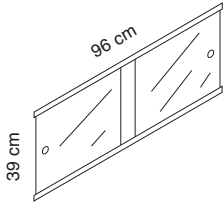
	NEXT 45			PREZZO PRICE PRIX
	ARTICOLO ITEM ARTICLE	COLORI COLOURS COULEURS	DESCRIZIONE DESCRIPTION DESCRIPTION	
	Supporti bianchi e grigi White and grey supports Supports blancs et gris Weisse und Graue Halter Soportes blancos y grises 8N4410-BO	BO	Ripiani in melaminico bianco 96X41 cm. <i>White melamine shelves 96X41 cm.</i> Tablettes en melaminé blanc 96X41 cm. <i>Fachböden aus weissem Melamin 96X41 cm</i> Estante acabado en melamina blanco 96X41 cm <i>(Supporti per montaggio inclusi - Couplings included - Avec joints - Inklusive Halterungen - Soportes incluidos)</i>	CHF 93
	Supporti bianchi e grigi White and grey supports Supports blancs et gris Weisse und Graue Halter Soportes blancos y grises 8N4460-BO	BO	Ripiani in melaminico bianco 56X41 cm. <i>White melamine shelves 56X41 cm.</i> Tablettes en melaminé blanc 56X41 cm. <i>Fachböden aus weissem Melamin 56X41 cm</i> Estante acabado en melamina blanco 56X41 cm <i>(Supporti per montaggio inclusi - Couplings included - Avec joints - Inklusive Halterungen - Soportes incluidos)</i>	CHF 71
	Supporti bianchi - White supports - Supports blancs - Weisse Halter - Soportes blancos 8N4312-BO	BO	Ripiani in acciaio verniciato cm 41x96. <i>Epoxy-coated steel shelves 41x96 cm.</i> Rayons en tôle d'acier peint époxy 41x96 cm <i>Pulverlackierter Fachboden 41 x 96 cm.</i> Estantes en acero barnizado con polvos epoxidicos de 41 x 96 cm. <i>(Supporti per montaggio inclusi - Couplings included - Avec joints - Inklusive Halterungen - Soportes incluidos)</i>	CHF 93
	Supporti grigi - Grey supports - Supports gris - Graue Halter - Soportes grises 8N4312-GM	GM		
	Supporti bianchi - White supports - Supports blancs - Weisse Halter - Soportes blancos 8N4362-BO	BO	Ripiani in acciaio verniciato cm 41x56. <i>Epoxy-coated steel shelves 41x56 cm.</i> Rayons ten tôle d'acier peint époxy 41x56 cm <i>Pulverlackierter Fachboden 41 x 56 cm.</i> Estantes en acero barnizado con polvos epoxidicos de 41 x 56 cm <i>(Supporti per montaggio inclusi - Couplings included - Avec joints - Inklusive Halterungen - Soportes incluidos)</i>	CHF 83
	Supporti grigi - Grey supports - Supports gris - Graue Halter - Soportes grises 8N4362-GM	GM		
	Supporti bianchi - White supports - Supports blancs - Weisse Halter - Soportes blancos 8N4310-BO	BO	Ripiani forati in acciaio verniciato 96x41 cm. <i>Perforated steel shelves 96x41 cm.</i> Rayons en tôle d'acier perforé peint époxy 96x41 cm <i>Pulverlackierter Fachboden aus Stahl 96x41 cm.</i> Estantes en acero barnizado con polvos epoxidicos de 96x41 cm. <i>(Supporti per montaggio inclusi - Couplings included - Avec joints - Inklusive Halterungen - Soportes incluidos)</i>	CHF 132
	Supporti grigi - Grey supports - Supports gris - Graue Halter - Soportes grises 8N4310-GM	GM		
	Supporti bianchi - White supports - Supports blancs - Weisse Halter - Soportes blancos 8N4360-BO	BO	Ripiani forati in acciaio verniciato 56x41cm. <i>Perforated steel shelves 56x41 cm.</i> Rayons en tôle d'acier perforé peint époxy 56x41 cm <i>Pulverlackierter Fachboden aus Stahl 56x41 cm.</i> Estantes en acero barnizado con polvos epoxidicos de 56x41 cm. <i>(Supporti per montaggio inclusi - Couplings included - Avec joints - Inklusive Halterungen - Soportes incluidos)</i>	CHF 127
	Supporti grigi - Grey supports - Supports gris - Graue Halter - Soportes grises 8N4360-GM	GM		

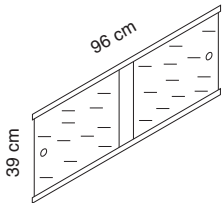
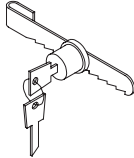
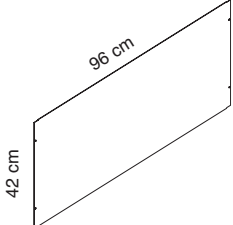
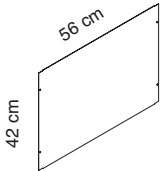
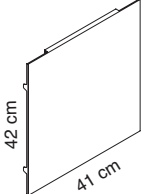
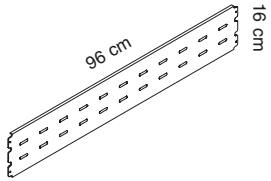
	NEXT 45			PREZZO PRICE PRIX
	ARTICOLO ITEM ARTICLE	COLORI COLOURS COULEURS	DESCRIZIONE DESCRIPTION DESCRIPTION	
	Supporti bianchi - White supports - Supports blancs - Weisse Halter - Soportes blancos 8N4710-BO	T	Ripiani in vetro temperato trasparente spessore 8 mm 96X41 cm. <i>8 mm tempered transparent glass shelves 96x41 cm</i> Tablettes en verre trempé transparent épaisseur 8 mm. 96X41 cm.	CHF 168
	Supporti grigi - Grey supports - Supports gris - Graue Halter - Soportes grises 8N4710-GR	T	<i>Regalböden aus gehärtetem Sicherheitsglas, transparent, Stärke 8 mm. 96x41 cm.</i> Estantes en vidrio templado transparente espesor 8 mm. 96X41 cm. (Supporti per montaggio inclusi - Couplings included - Avec joints - Inklusive Halterungen - Soportes incluidos)	
	Supporti bianchi - White supports - Supports blancs - Weisse Halter - Soportes blancos 8N4760-BO	T	Ripiani in vetro temperato trasparente spessore 8 mm 56x41 cm. <i>8 mm tempered transparent glass shelves 56x41 cm</i> Tablettes en verre trempé transparent épaisseur 8 mm. 56x41 cm.	CHF 163
	Supporti grigi - Grey supports - Supports gris - Graue Halter - Soportes grises 8N4760-GR	T	<i>Regalböden aus gehärtetem Sicherheitsglas, transparent, Stärke 8 mm. 56x41 cm.</i> Estantes en vidrio templado transparente espesor 8 mm. 56x41 cm. (Supporti per montaggio inclusi - Couplings included - Avec joints - Inklusive Halterungen - Soportes incluidos)	
	Supporti bianchi - White supports - Supports blancs - Weisse Halter - Soportes blancos 8N4610-BO	AC	Ripiani in vetro temperato acidato spessore 8 mm 96X41 cm. <i>8 mm tempered satin glass shelves 96x41 cm</i> Tablettes en verre trempé satiné épaisseur 8 mm. 96X41 cm.	CHF 209
	Supporti grigi - Grey supports - Supports gris - Graue Halter - Soportes grises 8N4610-GR	AC	<i>Regalböden aus gehärtetem Sicherheitsglas, satiniert, Stärke 8 mm. 96x41 cm.</i> Estantes en vidrio templado satinado espesor 8 mm. 96X41 cm. (Supporti per montaggio inclusi - Couplings included - Avec joints - Inklusive Halterungen - Soportes incluidos)	
	Supporti bianchi - White supports - Supports blancs - Weisse Halter - Soportes blancos 8N4660-BO	AC	Ripiani in vetro temperato acidato spessore 8 mm 56X41 cm. <i>8 mm tempered satin glass shelves 56x41 cm</i> Tablettes en verre trempé satiné épaisseur 8 mm. 56X41 cm.	CHF 202
	Supporti grigi - Grey supports - Supports gris - Graue Halter - Soportes grises 8N4660-GR	AC	<i>Regalböden aus gehärtetem Sicherheitsglas, satiniert, Stärke 8 mm. 56x41 cm.</i> Estantes en vidrio templado satinado espesor 8 mm. 56X41 cm. (Supporti per montaggio inclusi - Couplings included - Avec joints - Inklusive Halterungen - Soportes incluidos)	
 <p>** Articolo disponibile fino ad esaurimento scorte ** Item available until stock lasts</p>	Supporti bianchi e grigi - White and grey supports - Supports blancs et gris - Weisse und Graue Halter - Soportes blancos y grises 8N4510		Ripiani in melaminico finitura rovere sbiancato 96X41 cm. <i>Bleached oak melamine shelves 96x41 cm.</i> Tablettes en melaminé finition rouvre blancs 96x41 cm. <i>Fachböden aus Melamin, Ausführung Eichenholz gebleicht 96x41 cm</i> Estante acabado en melamina de roble blanqueada 96x41 cm. (Supporti per montaggio inclusi - Couplings included - Avec joints - Inklusive Halterungen - Soportes incluidos)	CHF 96
 <p>** Articolo disponibile fino ad esaurimento scorte ** Item available until stock lasts</p>	Supporti bianchi e grigi - White and grey supports - Supports blancs et gris - Weisse und Graue Halter - Soportes blancos y grises 8N4560		Ripiani in melaminico finitura rovere sbiancato 56x41 cm. <i>Bleached oak melamine shelves 56x41 cm.</i> Tablettes en melaminé finition rouvre blancs 56x41 cm. <i>Fachböden aus Melamin, Ausführung Eichenholz gebleicht 56x41 cm</i> Estante acabado en melamina de roble blanqueada 56x41 cm. (Supporti per montaggio inclusi - Couplings included - Avec joints - Inklusive Halterungen - Soportes incluidos)	CHF 88

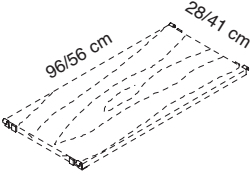
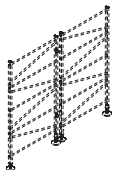
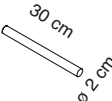
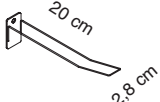
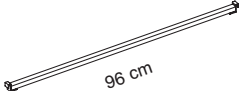
	NEXT 45			PREZZO PRICE PRIX
	ARTICOLO ITEM ARTICLE	COLORI COLOURS COULEURS	DESCRIZIONE DESCRIPTION DESCRIPTION	
	8N210-BO	BO	<p>Coppia bordi a L in acciaio verniciato con polveri epossidiche per ripiani 8N4310-BO / 8N4310-GM</p> <p><i>Pair of epoxy-coated L-shaped steel profiles for shelves for shelf 8N4310-BO / 8N4310-GM</i></p> <p>Paire bords en L en acier peint époxy pour tablette 8N4310-BO / 8N4310-GM</p>	<p>CHF 94</p> <p>(Prezzo per 2 pz) (Price for 2 pcs) (Prix pour 2 pcs) (Preis für 2 Stücke) (Precio para 2 pzs)</p>
	8N210-GM	GM	<p><i>2 Pulverlackiertes L-Profil für Fachboden für 8N4310-BO / 8N4310-GM</i></p> <p>Set 2 pzs perfil frontal para estantes 8N4310-BO / 8N4310-GM</p>	
	8N212-BO	BO	<p>Coppia bordi a L in acciaio verniciato con polveri epossidiche per ripiani 8N4360-BO / 8N4360-GM</p> <p><i>Pair of epoxy-coated L-shaped steel profiles for shelves for shelf 8N4360-BO / 8N4360-GM</i></p> <p>Paire bords en L en acier peint époxy pour tablette 8N4360-BO / 8N4360-GM</p>	<p>CHF 91</p> <p>(Prezzo per 2 pz) (Price for 2 pcs) (Prix pour 2 pcs) (Preis für 2 Stücke) (Precio para 2 pzs)</p>
	8N212-GM	GM	<p><i>2 Pulverlackiertes L-Profil für Fachboden für 8N4360-BO / 8N4360-GM</i></p> <p>Set 2 pzs perfil frontal para estantes 8N4360-BO / 8N4360-GM</p>	
	8N220-BO	BO	<p>Coppia bordi a L in acciaio verniciato con polveri epossidiche per ripiani 8N3312-BO / 8N3312-GM</p> <p><i>Pair of epoxy-coated L-shaped steel profiles for shelves for shelf 8N3312-BO / 8N3312-GM</i></p> <p>Paire bords en L en acier peint époxy pour tablette 8N3312-BO / 8N3312-GM</p>	<p>CHF 48</p> <p>(Prezzo per 2 pz) (Price for 2 pcs) (Prix pour 2 pcs) (Preis für 2 Stücke) (Precio para 2 pzs)</p>
	8N220-GM	GM	<p><i>2 Pulverlackiertes L-Profil für Fachboden für 8N3312-BO / 8N3312-GM</i></p> <p>Set 2 pzs perfil frontal para estantes 8N3312-BO / 8N3312-GM</p>	
	8N222-BO	BO	<p>Coppia bordi a L in acciaio verniciato con polveri epossidiche per ripiani 8N3362-BO / 8N3362-GM</p> <p><i>Pair of epoxy-coated L-shaped steel profiles for shelves for shelf 8N3362-BO / 8N3362-GM</i></p> <p>Paire bords en L en acier peint époxy pour tablette 8N3362-BO / 8N3362-GM</p>	<p>CHF 45</p> <p>(Prezzo per 2 pz) (Price for 2 pcs) (Prix pour 2 pcs) (Preis für 2 Stücke) (Precio para 2 pzs)</p>
	8N222-GM	GM	<p><i>2 Pulverlackiertes L-Profil für Fachboden für 8N3362-BO / 8N3362-GM</i></p> <p>Set 2 pzs perfil frontal para estantes 8N3362-BO / 8N3362-GM</p>	
	8N201-BO	BO	<p>Coppia ante scorrevoli in acciaio verniciato per ripiano da 96 cm. Da utilizzare con piani 8N4310-BO / 8N4310-GM.</p> <p><i>Pair of epoxy-coated steel sliding doors for shelves width 96 cm. To be used with shelves 8N4310-BO / 8N4310-GM.</i></p> <p>Paire portes couliss. en acier peint pour rayon de 96 cm. A utiliser avec tablettes 8N4310-BO / 8N4310-GM.</p>	<p>CHF 213</p>
	8N201-GM	GM	<p><i>Paar pulverlackierte Schiebetüren für Böden 96 cm breit. Für Regalboden Art. 8N4310-BO / 8N4310-GM.</i></p> <p>Puertas correderas en acero barnizado 96 cm. Para ser utilizadas con estantes ref. 8N4310-BO / 8N4310-GM.</p>	
	8N203-BO	T	<p>Coppia ante scorrevoli in vetro temperato per ripiano da 96 cm. Da utilizzare con piani 8N4310-BO / 8N4310-GM.</p> <p><i>Pair of tempered glass sliding doors for shelves width 96 cm. To be used with shelves 8N4310-BO / 8N4310-GM.</i></p> <p>Paire portes coulissantes en verre trempé pour rayon de 96 cm. A utiliser avec tablettes 8N4310-BO / 8N4310-GM.</p>	<p>CHF 237</p>
	8N203-GM	T	<p><i>Paar Schiebetüren Klarglas für Böden 96 cm breit. Für Regalboden Art. 8N4310-BO / 8N4310-GM.</i></p> <p>Puertas correderas en cristal templado 96 cm. Para ser utilizadas con estantes ref. 8N4310-BO / 8N4310-GM.</p>	

	NEXT 45			PREZZO PRICE PRIX
	ARTICOLO ITEM ARTICLE	COLORI COLOURS COULEURS	DESCRIZIONE DESCRIPTION DESCRIPTION	
	8N205-BO	AC	Coppia ante scorrevoli vetro temperato satinato per ripiano 96 cm. Da utilizzare con piani 8N4310-BO / 8N4310-GM . <i>Pair of satin tempered glass sliding doors for shelves 96 cm. To be used with shelves 8N4310-BO / 8N4310-GM.</i>	CHF 272
	8N205-GM	AC	Paire portes couliss. en verre satiné trempé pour rayon de 96 cm. A utiliser avec teblettes 8N4310-BO / 8N4310-GM . <i>Paar Schiebetüren Mattglas für Böden 96 cm breit. Für Regalboden Art. 8N4310-BO / 8N4310-GM.</i> Puertas correderas en cristal opaco templado 96 cm. Para ser utilizadas con estantes ref. 8N4310-BO / 8N4310-GM .	
	82659	CR	Serratura per ante scorrevoli in vetro. Solo per cod. 8N203-BO / 8N203-GM <i>Lock for glass sliding doors. Only for code 8N203-BO / 8N203-GM</i> Serrure pour portes coulissantes en verre. Seulement pour réf. 8N203-BO / 8N203-GM . <i>Schloß für Glasschiebetüren. Für Art. 8N203-BO / 8N203-GM</i> Cerradura para las puertas correderas cristal. Para ref. 8N203-BO / 8N203-GM	CHF 35
	8N214-BO	BO	Chiusura posteriore in lamiera di acciaio verniciato con polveri epossidiche lungh. 96 cm. <i>Epoxy-coated steel back panel width 96 cm.</i> Panneau arrière tôle d'acier peint époxy l. 96 cm <i>Rückwände aus beschichtetem Stahlblech 96 cm breit.</i>	CHF 132
	8N214-GM	GM	Cerradura trasera en acero barnizado epoxi. 96 cm (Viti incluse - <i>Screws included</i> - Avec vis - <i>Schrauben inklusive</i> - Tornillos incluidos)	
	8N216-BO	BO	Chiusura posteriore in lamiera di acciaio verniciato con polveri epossidiche lungh. 56 cm. <i>Epoxy-coated steel back panel width 56 cm.</i> Panneau arrière tôle d'acier peint époxy l. 56 cm <i>Rückwände aus beschichtetem Stahlblech 56 cm breit.</i>	CHF 130
	8N216-GM	GM	Cerradura trasera en acero barnizado epoxi. 56 cm (Viti incluse - <i>Screws included</i> - Avec vis - <i>Schrauben inklusive</i> - Tornillos incluidos)	
	8N4218-BO	BO	Coppia chiusure laterali esterne in lamiera di acciaio verniciato con polveri epossidiche 42x41 cm. <i>Pair of external lateral closing elements in epoxy-coated steel 42x41 cm.</i>	CHF 118 (Prezzo per 2 pz) (Price for 2 pcs) (Prix pour 2 pcs) (Preis für 2 Stücke) (Precio para 2 pzs)
	8N4218-GM	GM	Paire panneaux latéraux en tôle d'acier peint époxy 42x41 cm <i>Außenverkleidungen aus beschichtetem Stahlblech 42x41 cm breit.</i> Set 2 pzs cerraduras externas 42x41 cm (Confezione da 2 pezzi - <i>Set of 2 pcs</i> - Set 2 pièces - <i>Set mit 2 Stücke</i> - Set 2 pzs)	
	8N223-BO	BO	Supporto universale L. 96 cm <i>Universal support L 96 cm.</i>	CHF 137
	8N223-GM	GM	Support universel L 96 cm <i>Universaltraverse 96 cm breit.</i> Soporte universal L 96 cm	

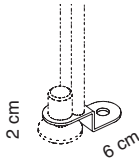
	NEXT 45			PREZZO PRICE PRIX
	ARTICOLO ITEM ARTICLE	COLORI COLOURS COULEURS	DESCRIZIONE DESCRIPTION DESCRIPTION	
	80674	GM	<p>Rinforzi per ripiani top di copertura posizionati ad altezza uguale o inferiore a 100 cm. Per cod. 8N4410-BO / 8N4460-BO / 8N4510 / 8N4560</p> <p><i>Strengthening for top shelves on units 100 cm high or lower. For codes 8N4410-BO / 8N4460-BO / 8N4510 / 8N4560</i></p> <p>Renforcement pour tablette dessus, en cas l'hauteur est 100 cm ou inférieure. Pur réf. 8N4410-BO / 8N4460-BO / 8N4510 / 8N4560</p> <p>Verstärkung für das Abschlusstabl bei einer Regalhöhe von oder unter 100 cm. Für Art. 8N4410-BO / 8N4460-BO / 8N4510 / 8N4560</p> <p>Refuerzo para estante superior situado a una altura de 100 cm o inferior. Para ref. 8N4410-BO / 8N4460-BO / 8N4510 / 8N4560</p> <p>(UNI EN 1727, EN 14073-2, EN 14073-3)</p>	CHF 21
	80646		<p>Coppia giunti per unione bifronte</p> <p><i>2 Joints for side up-right connection</i></p> <p>2 Joints pour accouplement bifrontal</p> <p><i>Verbindungssatz</i></p> <p>Par de juntas para connexion</p> <p>(Confezione da 2 pezzi - <i>Set of 2 pcs</i> - Set 2 pièces - Set mit 2 Stücke - Set 2 pzs)</p>	CHF 31 (Prezzo per 2 pz) (Price for 2 pcs) (Prix pour 2 pcs) (Preis für 2 Stücke) (Precio para 2 pzs)
	82763	C	<p>Supporto in acciaio cromato</p> <p><i>Chrome-plated support</i></p> <p>Support en acier chromé</p> <p><i>Halter aus verchromtem Stahl</i></p> <p>Soporte en acero cromado</p>	CHF 36
	82765	C	<p>Portablister in acciaio cromato</p> <p><i>Chrome-plated blister holder</i></p> <p>Support en acier chromé</p> <p><i>Blisterhalter aus verchromtem Stahl</i></p> <p>Portablister en acero cromado</p>	CHF 18
	80636	CR	<p>Barra orizzontale cromata portabiti 96 cm.</p> <p><i>Chrome plated coat rail for shelves width 96 cm.</i></p> <p>Barre horizontale chromée portemanteau 96 cm</p> <p><i>Verchromte Garderobenstange zur Anbringung an 96 cm breite Fachböden.</i></p> <p>Barra horizontal cromada para colgar de 96 cm.</p> <p>(Supporti per montaggio inclusi - <i>Couplings included</i> - Avec joints - <i>Inklusive Halterungen</i> - Soportes incluidos)</p>	CHF 142
	82578	N	<p>Passacavi in tecnopolimero.</p> <p><i>High-tech polymer cable holder.</i></p> <p>Séparateurs de cablagés en polymère</p> <p><i>Kunststoff-Kabelhalter.</i></p> <p>Pasacables en tecnopolimero.</p> <p>(Confezione da 8 pezzi - <i>Set of 8 pcs</i> - Set 8 pièces - Set mit 8 Stücke - Set 8 pzs)</p>	CHF 18 (Prezzo per 8 pz) (Price for 8 pcs) (Prix pour 8 pcs) (Preis für 8 Stücke) (Precio para 8 pzs)

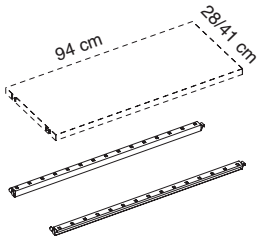
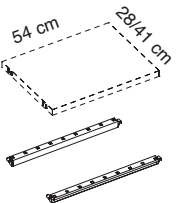
	NEXT 45			PREZZO PRICE PRIX
	ARTICOLO ITEM ARTICLE	COLORI COLOURS COULEURS	DESCRIZIONE DESCRIPTION DESCRIPTION	
	80644	GM	<p>Fissaggio a terra per montanti Next. <i>Floor fixing for Next uprights.</i> Fixation au sol pour montants Next <i>Bodenbefestigung für Next Seitenteile.</i> Fijacion a suelo para lateral Next</p> <p>(Confezione da 2 pezzi - <i>Set of 2 pcs</i> - Set 2 pièces - <i>Set mit 2 Stücke</i> - Set 2 pzs)</p>	<p>CHF 28</p> <p>(Prezzo per 2 pz) (Price for 2 pcs) (Prix pour 2 pcs) (Preis für 2 Stücke) (Precio para 2 pzs)</p>
	82996	N	<p>Coppia squadrette per unione montanti a 90° <i>Pair of joints for 90° side uprights connection</i> Paire de joints pour juxtaposition montants à 90° <i>Halterstücke für Eckkombinationen 90°</i> Par de juntas para conexion laterales a 90°</p> <p>(Viti incluse - <i>Screws included</i> - Avec vis - <i>Schrauben inklusive</i> - Tornillos incluidos) (Confezione da 2 pezzi - <i>Set of 2 pcs</i> - Set mit 2 Stücke)</p>	<p>CHF 32</p> <p>(Prezzo per 2 pz) (Price for 2 pcs) (Prix pour 2 pcs) (Preis für 2 Stücke) (Precio para 2 pzs)</p>
	80670	GM	<p>80670 - Coppia rinforzi per ripiani top di copertura posizionati ad altezza uguale o inferiore a 100 cm. Per cod. 8N4312-BO / 8N4312-GM</p> <p>80670 - <i>Strengthening for top shelves on units 100 cm high or lower.</i> <i>For codes 8N4312-BO / 8N4312-GM</i></p> <p>80670 - Renforcement pour tablette dessus, en cas l'hauteur est 100 cm ou inférieure. Pur réf. 8N4312-BO / 8N4312-GM</p> <p>80670 - <i>Refuerzo para estante superior situado a una altura de 100 cm o inferior.</i> <i>Para ref. 8N3312-BO / 8N3312-GM</i></p> <p>80670 - Verstärkung für das Abschlusstablar bei einer Regalhöhe von oder unter 100 cm. Für Art. 8N3312-BO / 8N3312-GM</p> <p>(UNI EN 1727, EN 14073-2, EN 14073-3)</p>	<p>CHF 40</p>
	80672	GM	<p>80672 - Coppia rinforzi per ripiani top di copertura posizionati ad altezza uguale o inferiore a 100 cm. Per cod. 8N4362-BO / 8N4362-GM</p> <p>80672 - <i>Strengthening for top shelves on units 100 cm high or lower.</i> <i>For codes 8N4362-BO / 8N4362-GM</i></p> <p>80672 - Renforcement pour tablette dessus, en cas l'hauteur est 100 cm ou inférieure. Pur réf. 8N4362-BO / 8N4362-GM</p> <p>80672 - <i>Refuerzo para estante superior situado a una altura de 100 cm o inferior.</i> <i>Para ref. 8N4362-BO / 8N4362-GM</i></p> <p>80672 - Verstärkung für das Abschlusstablar bei einer Regalhöhe von oder unter 100 cm. Für Art. 8N4362-BO / 8N4362-GM</p> <p>(UNI EN 1727, EN 14073-2, EN 14073-3)</p>	<p>CHF 38</p>





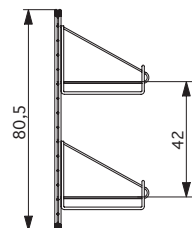
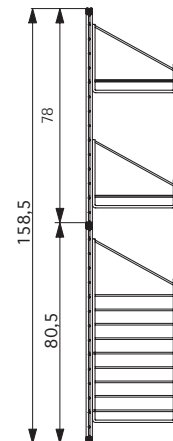
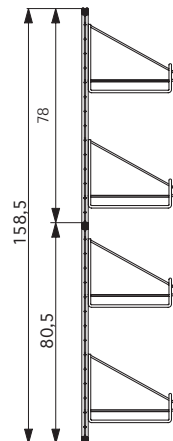
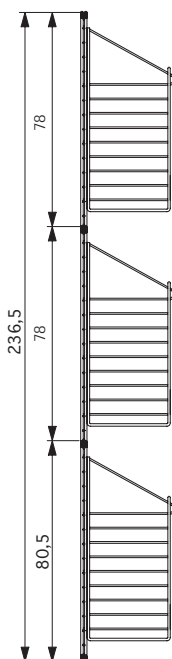
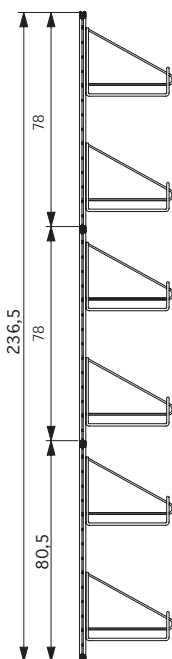
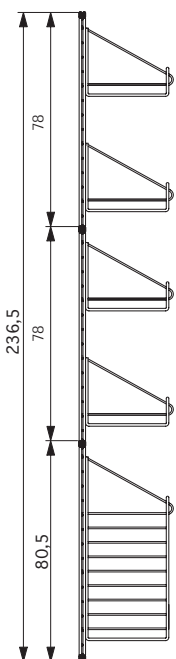
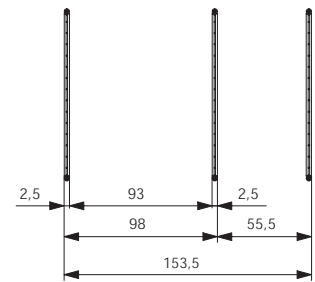
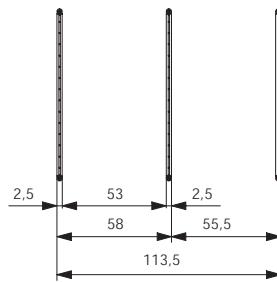
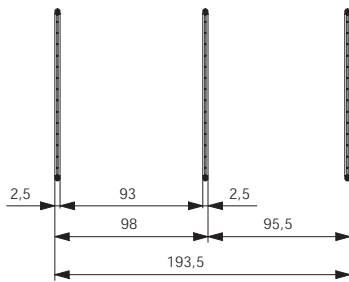
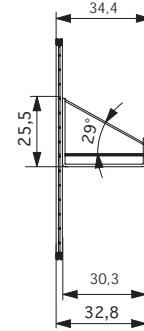
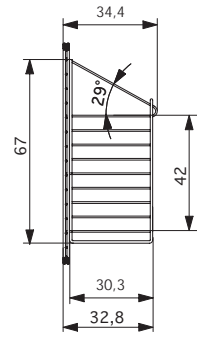
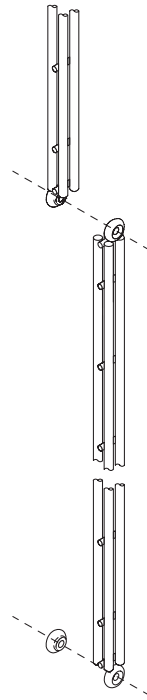
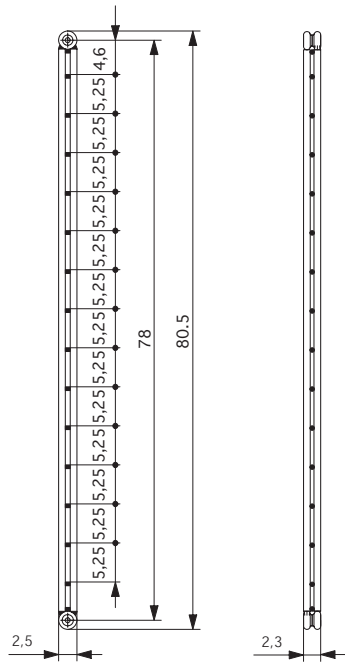

Creando

NEXT PARETE 32

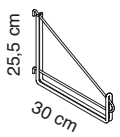
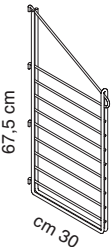
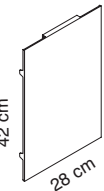
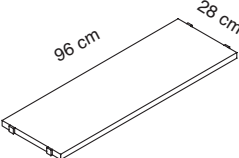
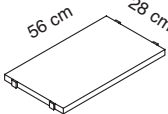

Dimensioni in cm - Dimensions in cm - Dimensions en cm - Dimensionen in cm - Dimensiones en cm

	NEXT PARETE 32			PREZZO PRICE PRIX
	ARTICOLO ITEM ARTICLE	COLORI COLOURS COULEURS	DESCRIZIONE DESCRIPTION DESCRIPTION	
	8NP310-BO	BO	<p>Montante a parete a cremagliera sovrapponibile in acciaio verniciato con polveri epossidiche. Portata max.50 Kg.</p> <p><i>Epoxy-coated steel rod staking racks. Maximum load 50 Kg.</i></p>	CHF 72
	8NP310-GM	GM	<p>Montant mural à crémaillère superposable en acier peint epoxy. Charge utile 50 Kg</p> <p><i>Pulverlackierte Wandschiene. Tragfähigkeit 50 Kgs.</i></p> <p>Lateral a pared en acero barnizado con polvos epoxi. Peso max. 50 Kg.</p>	
	8NP330-BO	BO	<p>Supporto in acciaio verniciato con polveri epossidiche per ripiani.</p> <p><i>Epoxy-coated steel shelf brackets.</i></p> <p>Support en acier peint epoxy pour rayons</p> <p><i>Pulverlackierte Fachbodenträger für Boden</i></p>	CHF 67 (Prezzo per 2 pz) (Price for 2 pcs) (Prix pour 2 pcs) (Preis für 2 Stücke) (Precio para 2 pzs)
	8NP330-GM	GM	<p>Soportes para estantes en acero barnizado con polvos epoxi</p> <p>(Confezione da 2 pz - Set of 2 pcs - Set 2 pièces - Set mit 2 Stücke - Set 2 pzs)</p>	
	8NP320-BO	BO	<p>Supporto in acciaio verniciato con polveri epossidiche per ante scorrevoli</p> <p><i>Epoxy-coated shelf brackets for sliding door cabinet</i></p> <p>Support en acier peint epoxy pour portes coulissantes</p> <p><i>Pulverlackierte Fachbodenträger für Schiebtürenschränke</i></p>	CHF 108
	8NP320-GM	GM	<p>Soporte para puertas correderas en acero barnizado con polvos epoxi.</p>	
	8N3218-BO	BO	<p>Coppia chiusure laterali esterne in lamiera di acciaio verniciato con polveri epossidiche 42x28 cm.</p> <p><i>Pair of external lateral closing elements in epoxy-coated steel 42x28 cm.</i></p> <p>Paire panneaux latéraux en tôle d'acier peint epoxy 42x28 cm</p> <p><i>Außenverkleidungen aus beschichtetem Stahlblech 42x28 cm breit.</i></p>	CHF 115 (Prezzo per 2 pz) (Price for 2 pcs) (Prix pour 2 pcs) (Preis für 2 Stücke) (Precio para 2 pzs)
	8N3218-GM	GM	<p>Set 2 pzs cerraduras externas 42x28 cm</p> <p>(Confezione da 2 pezzi - Set of 2 pcs - Set 2 pièces - Set mit 2 Stücke - Set 2 pzs)</p>	
	8N3410-BO	BO	<p>Supporti bianchi e grigi White and grey supports Supports blancs et gris Weisse und Graue Halter Soportes blancos y grises</p> <p>Ripiani in melaminico bianco 96X28 cm.</p> <p><i>White melamine shelves 96X28 cm.</i></p> <p>Tablettes en melaminé fblanc 96X28 cm.</p> <p><i>Fachböden aus weissem Melamin 96X28 cm</i></p> <p>Estante acabado en melamina blanco 96X28 cm</p> <p>(Supporti per montaggio inclusi - Couplings included - Avec joints - Inklusive Halterungen - Soportes incluidos)</p>	CHF 81
	8N3460-BO	BO	<p>Supporti bianchi e grigi White and grey supports Supports blancs et gris Weisse und Graue Halter Soportes blancos y grises</p> <p>Ripiani in melaminico bianco 56X28 cm.</p> <p><i>White melamine shelves 56X28 cm.</i></p> <p>Tablettes en melaminé fblanc 56X28 cm.</p> <p><i>Fachböden aus weissem Melamin 58X28 cm</i></p> <p>Estante acabado en melamina blanco 56X28 cm</p> <p>(Supporti per montaggio inclusi - Couplings included - Avec joints - Inklusive Halterungen - Soportes incluidos)</p>	CHF 64

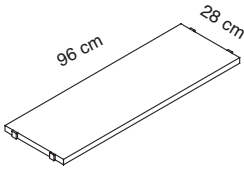
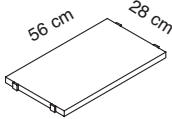
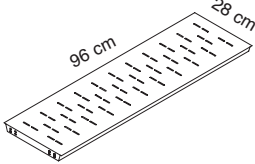
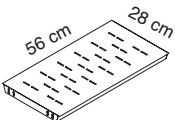
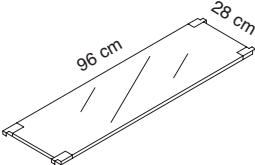
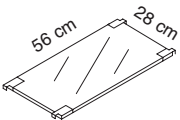
	NEXT 32			PREZZO PRICE PRIX
	ARTICOLO ITEM ARTICLE	COLORI COLOURS COULEURS	DESCRIZIONE DESCRIPTION DESCRIPTION	
	Supporti bianchi - White supports - Supports blancs - Weisse Halter - Soportes blancos 8N3312-BO	BO	Ripiani in acciaio verniciato cm 28 x 96. <i>Epoxy-coated steel shelves 28 x 96 cm.</i> Rayons en tôle d'acier peint époxy 28x96 cm <i>Pulverlackierter Fachboden 28 x 96 cm.</i>	CHF 88
	Supporti grigi - Grey supports - Supports gris - Graue Halter - Soportes grises 8N3312-GM	GM	Esatntes en acero barnizado con polvos epoxidicos de 41 x 96 cm (Supporti per montaggio inclusi - <i>Couplings included</i> - Avec joints - <i>Inklusive Halterungen</i> - Soportes incluidos)	
	Supporti bianchi - White supports - Supports blancs - Weisse Halter - Soportes blancos 8N3362-BO	BO	Ripiani in acciaio verniciato cm 28 x 56. <i>Epoxy-coated steel shelves 28 x 56 cm.</i> Rayons en tôle d'acier peint époxy 28x56 cm <i>Pulverlackierter Fachboden 28 x 56 cm.</i>	CHF 78
	Supporti grigi - Grey supports - Supports gris - Graue Halter - Soportes grises 8N3362-GM	GM	Esatantes en acero barnizado con polvos epoxidicos de 41 x 56 cm. (Supporti per montaggio inclusi - <i>Couplings included</i> - Avec joints - <i>Inklusive Halterungen</i> - Soportes incluidos)	
	Supporti bianchi - White supports - Supports blancs - Weisse Halter - Soportes blancos 8N3310-BO	BO	Ripiani forati in acciaio verniciato 96X28 cm. <i>Perforated steel shelves 96x28 cm.</i> Rayons en tôle d'acier perforé peint époxy 96x28 cm <i>Pulverlackierter Fachboden aus Stahl 96x28 cm.</i>	CHF 127
	Supporti grigi - Grey supports - Supports gris - Graue Halter - Soportes grises 8N3310-GM	GM	Estantes en acero barnizado con polvos epoxidicos de 96x28 cm. (Supporti per montaggio inclusi - <i>Couplings included</i> - Avec joints - <i>Inklusive Halterungen</i> - Soportes incluidos)	
	Supporti bianchi - White supports - Supports blancs - Weisse Halter - Soportes blancos 8N3360-BO	BO	Ripiani forati in acciaio verniciato 56x28 cm. <i>Perforated steel shelves 56x28 cm.</i> Rayons en tôle d'acier perforé peint époxy 56x28 cm <i>Pulverlackierter Fachboden aus Stahl 56x28 cm.</i>	CHF 117
	Supporti grigi - Grey supports - Supports gris - Graue Halter - Soportes grises 8N3360-GM	GM	Estantes en acero barnizado con polvos epoxidicos de 56x28 cm. (Supporti per montaggio inclusi - <i>Couplings included</i> - Avec joints - <i>Inklusive Halterungen</i> - Soportes incluidos)	
	Supporti bianchi - White supports - Supports blancs - Weisse Halter - Soportes blancos 8N3710-BO	T	Ripiani in vetro temperato trasparente spessore 8 mm 96X28 cm. <i>8 mm tempered transparent glass shelves 96x28 cm</i> Tablettes en verre trempé transparent épaisseur 8 mm. 96X28 cm.	CHF 144
	Supporti grigi - Grey supports - Supports gris - Graue Halter - Soportes grises 8N3710-GR	T	Regalböden aus gehärtetem Sicherheitsglas, transparent, Stärke 8 mm. 96x28 cm. Estantes en vidrio templado transparente espesor 8 mm. 96X28 cm. (Supporti per montaggio inclusi - <i>Couplings included</i> - Avec joints - <i>Inklusive Halterungen</i> - Soportes incluidos)	
	Supporti bianchi - White supports - Supports blancs - Weisse Halter - Soportes blancos 8N3760-BO	T	Ripiani in vetro temperato trasparente spessore 8 mm 56x28 cm. <i>8 mm tempered transparent glass shelves 56x28 cm</i> Tablettes en verre trempé transparent épaisseur 8 mm. 56x28 cm.	CHF 139
	Supporti grigi - Grey supports - Supports gris - Graue Halter - Soportes grises 8N3760-GR	T	Regalböden aus gehärtetem Sicherheitsglas, transparent, Stärke 8 mm. 56x28 cm. Estantes en vidrio templado transparente espesor 8 mm. 56x28 cm. (Supporti per montaggio inclusi - <i>Couplings included</i> - Avec joints - <i>Inklusive Halterungen</i> - Soportes incluidos)	

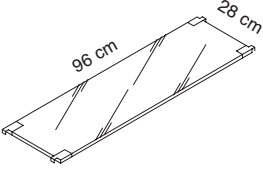
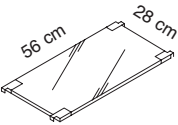
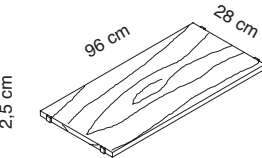
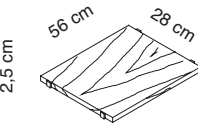
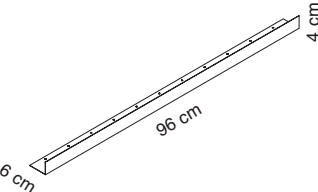
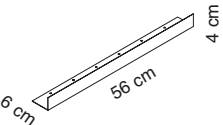
	NEXT PARETE 32			PREZZO PRICE PRIX
	ARTICOLO ITEM ARTICLE	COLORI COLOURS COULEURS	DESCRIZIONE DESCRIPTION DESCRIPTION	
	Supporti bianchi - White supports - Supports blancs - Weisse Halter - Soportes blancos	AC	Ripiani in vetro temperato acidato spessore 8 mm 96X28 cm. <i>8 mm tempered satin glass shelves 96x28 cm</i> Tablettes en verre trempé satiné épaisseur 8 mm. 96X28 cm.	CHF 185
	Supporti grigi - Grey supports - Supports gris - Graue Halter - Soportes grises	AC	<i>Regalböden aus gehärtetem Sicherheitsglas, satiniert, Stärke 8 mm. 96x28 cm.</i> Estantes en vidrio templado satinado espesor 8 mm. 96X28 cm. (Supporti per montaggio inclusi - Couplings included - Avec joints - Inklusive Halterungen - Soportes incluidos)	
	Supporti bianchi - White supports - Supports blancs - Weisse Halter - Soportes blancos	AC	Ripiani in vetro temperato acidato spessore 8 mm 56x28 cm. <i>8 mm tempered satin glass shelves 56x28 cm</i> Tablettes en verre trempé satiné épaisseur 8 mm. 56x28 cm.	CHF 178
	Supporti grigi - Grey supports - Supports gris - Graue Halter - Soportes grises	AC	<i>Regalböden aus gehärtetem Sicherheitsglas, satiniert, Stärke 8 mm. 56x28 cm.</i> Estantes en vidrio templado satinado espesor 8 mm. 56x28 cm. (Supporti per montaggio inclusi - Couplings included - Avec joints - Inklusive Halterungen - Soportes incluidos)	
 <p>** Articolo disponibile fino ad esaurimento scorte ** Item available until stock lasts</p>	Supporti bianchi e grigi White and grey supports Supports blancs et gris Weisse und Graue Halter Soportes blancos y grises	AC	Ripiani in melaminico finitura rovere sbiancato 96X28 cm. <i>Bleached oak melamine shelves 96x28 cm.</i> Tablettes en melaminé finition rouvre blancs 96x28 cm. <i>Fachböden aus Melamin, Ausführung Eichenholz gebleicht 96x28 cm</i> Estante acabado en melamina de roble blanqueada 96x28 cm (Supporti per montaggio inclusi - Couplings included - Avec joints - Inklusive Halterungen - Soportes incluidos)	CHF 85
 <p>** Articolo disponibile fino ad esaurimento scorte ** Item available until stock lasts</p>	Supporti bianchi e grigi White and grey supports Supports blancs et gris Weisse und Graue Halter Soportes blancos y grises	AC	Ripiani in melaminico finitura rovere sbiancato 56x28 cm. <i>Bleached oak melamine shelves 56x28 cm.</i> Tablettes en melaminé finition rouvre blancs 56x28 cm. <i>Fachböden aus Melamin, Ausführung Eichenholz gebleicht 56x28 cm</i> Estante acabado en melamina de roble blanqueada 56x28 cm (Supporti per montaggio inclusi - Couplings included - Avec joints - Inklusive Halterungen - Soportes incluidos)	CHF 71
	8N210-BO	BO	Coppia bordi a L in acciaio verniciato con polveri epossidiche per ripiani 8N3310-BO / 8N3310-GM <i>Pair of epoxy-coated L-shaped steel profiles for shelves for shelf 8N3310-BO / 8N3310-GM</i>	CHF 94 (Prezzo per 2 pz) (Price for 2 pcs) (Prix pour 2 pcs) (Preis für 2 Stücke) (Precio para 2 pzs)
	8N210-GM	GM	Paire bords en L en acier peint époxy pour tablette 8N3310-BO / 8N3310-GM <i>2 Pulverlackiertes L-Profil für Fachboden für 8N3310-BO / 8N3310-GM</i> Set 2 pzs perfil frontal para estantes 8N3310-BO / 8N3310-GM	
	8N212-BO	BO	Coppia bordi a L in acciaio verniciato con polveri epossidiche per ripiani 8N3360-BO / 8N3360-GM <i>Pair of epoxy-coated L-shaped steel profiles for shelves for shelf 8N3360-BO / 8N3360-GM</i>	CHF 91 (Prezzo per 2 pz) (Price for 2 pcs) (Prix pour 2 pcs) (Preis für 2 Stücke) (Precio para 2 pzs)
	8N212-GM	GM	Paire bords en L en acier peint époxy pour tablette 8N3360-BO / 8N3360-GM <i>2 Pulverlackiertes L-Profil für Fachboden für 8N3360-BO / 8N3360-GM</i> Set 2 pzs perfil frontal para estantes 8N3360-BO / 8N3360-GM	

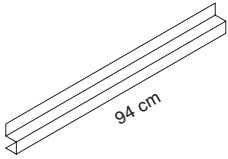
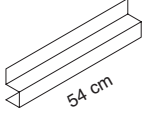
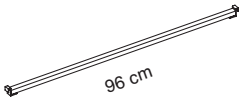
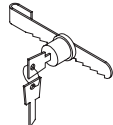
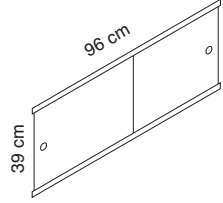
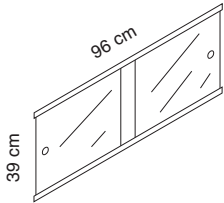
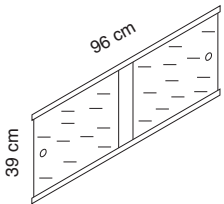
	NEXT PARETE 32			PREZZO PRICE PRIX
	ARTICOLO ITEM ARTICLE	COLORI COLOURS COULEURS	DESCRIZIONE DESCRIPTION DESCRIPTION	
	8N220-BO	BO	Coppia bordi a L in acciaio verniciato con polveri epossidiche per ripiani 8N3312-BO / 8N3312-GM <i>Pair of epoxy-coated L-shaped steel profiles for shelves for shelf 8N3312-BO / 8N3312-GM</i>	CHF 48 (Prezzo per 2 pz) (Price for 2 pcs) (Prix pour 2 pcs) (Preis für 2 Stücke) (Precio para 2 pzs)
	8N220-GM	GM	Paire bords en L en acier peint époxy pour tablette 8N3312-BO / 8N3312-GM <i>2 Pulverlackiertes L-Profil für Fachboden für 8N3312-BO / 8N3312-GM</i> Set 2 pzs perfil frontal para estantes 8N3312-BO / 8N3312-GM	
	8N222-BO	BO	Coppia bordi a L in acciaio verniciato con polveri epossidiche per ripiani 8N3362-BO / 8N3362-GM <i>Pair of epoxy-coated L-shaped steel profiles for shelves for shelf 8N3362-BO / 8N3362-GM</i>	CHF 45 (Prezzo per 2 pz) (Price for 2 pcs) (Prix pour 2 pcs) (Preis für 2 Stücke) (Precio para 2 pzs)
	8N222-GM	GM	Paire bords en L en acier peint époxy pour tablette 8N3362-BO / 8N3362-GM <i>2 Pulverlackiertes L-Profil für Fachboden für 8N3362-BO / 8N3362-GM</i> Set 2 pzs perfil frontal para estantes 8N3362-BO / 8N3362-GM	
	80636	CR	Barra orizzontale cromata portabiti 96 cm. <i>Chrome plated coat rail for shelves width 96 cm.</i> Barre horizontale chromée portemanteau 96 cm <i>Verchromte Garderobenstange zur Anbringung an 96 cm breite Fachböden.</i> Barra horizontal cromada para colgar de 96 cm. <i>(Supporti per montaggio inclusi - Couplings included - Avec joints - Inklusive Halterungen - Soportes incluidos)</i>	CHF 142
	82659	CR	Serratura ante scorrevoli vetro per cod. 8N203-BO/8N203-GM <i>Lock for glass sliding doors for codes 8N203-BO / 8N203-GM</i> Serrure portes couliss. verre pour réf. 8N203-BO/8N203-GM <i>Schloß für Glasschiebetüren. Für Art. 8N203-BO / 8N203-GM</i> Cerradura puertas correderas cristal para 8N203-BO / 8N203-GM	CHF 35
	8N201-BO	BO	Coppia ante scorrevoli in acciaio verniciato per ripiano da 96 cm. Da utilizzare con piani 8N3310-BO / 8N3310-GM. <i>Pair of epoxy-coated steel sliding doors for shelves width 96 cm. To be used with shelves 8N3310-BO / 8N3310-GM.</i>	CHF 213
	8N201-GM	GM	Paire portes couliss. en acier peint pour rayon de 96 cm. A utiliser avec tablettes 8N3310-BO / 8N3310-GM. <i>Paar pulverlackierte Schiebetüren für Böden 96 cm breit. Für Regalboden Art. 8N3310-BO / 8N3310-GM.</i> Puertas correderas en acero barnizado 96 cm. Para ser utilizadas con estantes ref. 8N3310-BO / 8N3310-GM.	
	8N203-BO	T	Coppia ante scorrevoli in vetro temperato per ripiano da 96 cm. Da utilizzare con piani 8N3310-BO / 8N3310-GM. <i>Pair of tempered glass sliding doors for shelves width 96 cm. To be used with shelves 8N3310-BO / 8N3310-GM.</i>	CHF 237
	8N203-GM	T	Paire portes coulissantes en verre trempé pour rayon de 96 cm. A utiliser avec tablettes 8N3310-BO / 8N3310-GM. <i>Paar Schiebetüren Klarglas für Böden 96 cm breit. Für Regalboden Art. 8N3310-BO / 8N3310-GM.</i> Puertas correderas en cristal templado 96 cm. Para ser utilizadas con estantes ref. 8N3310-BO / 8N3310-GM.	
	8N205-BO	AC	Coppia ante scorrevoli vetro temperato satinato per ripiano 96 cm. Da utilizzare con piani 8N3310-BO / 8N3310-GM. <i>Pair of satin tempered glass sliding doors for shelves 96 cm. To be used with shelves 8N3310-BO / 8N3310-GM.</i>	CHF 272
	8N205-GM	AC	Paire portes couliss. en verre satiné trempé pour rayon de 96 cm. A utiliser avec tablettes 8N3310-BO / 8N3310-GM. <i>Paar Schiebetüren Mattglas für Böden 96 cm breit. Für Regalboden Art. 8N3310-BO / 8N3310-GM.</i> Puertas correderas en cristal opaco templado 96 cm. Para ser utilizadas con estantes ref. 8N3310-BO / 8N3310-GM.	